

Quantum® 1420 Series

Group 3 Standard
Order Form
500 lbs. weight capacity
Weight Capacity May Be Limited By Configuration



Quantum Rehab®

A Division of Pride Mobility Products Corporation®
182 Susquehanna Ave., Exeter, PA 18643
Phone: (866)800-2002 • Fax: (866) 707-3422

Account Number: _____
 Provider Name: _____
 Contact: _____
 Phone: _____
 Fax: _____
 Date: _____
 PO#: _____
 Marked For: _____
 Ship To: _____
 Address: _____
 City: _____ State: _____ Zip: _____
 Discount: _____
 Terms: _____
 Freight: _____
 Taken By: _____

SET-TO-SPEC*

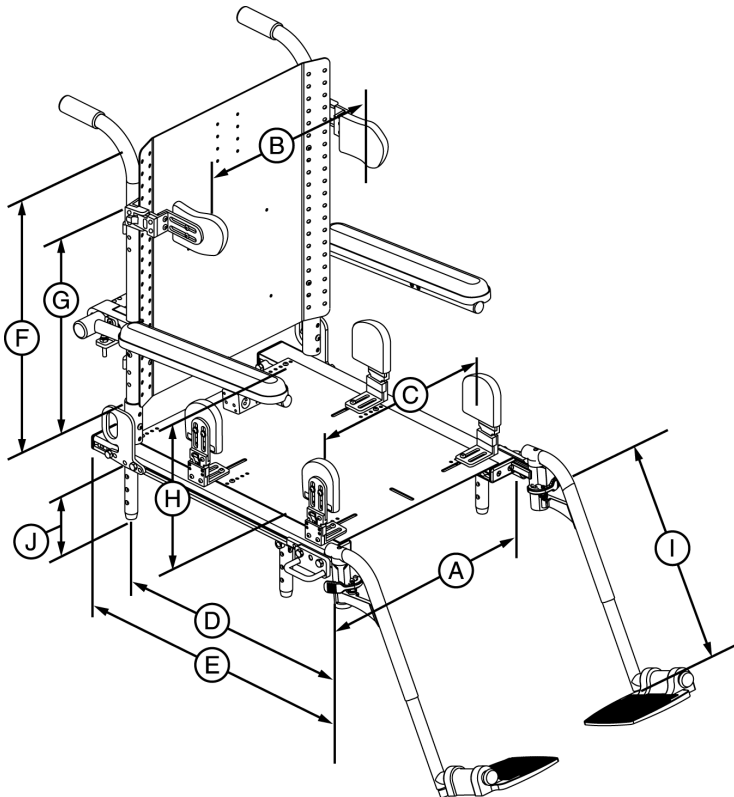

Please Supply Client Information:

Client Height: _____
 Client Weight: _____

- A. Seat Width: _____
- B. Lateral Offset: _____
- C. Hip/Thigh Lateral Offset: _____
- D. Center of Gravity: Optimized based on seat dimensions
- E. Seat Depth: _____
- F. Back Height from Pan: _____
- G. Lateral Height from Pan: _____
- H. Armrest Height from Pan: _____
- I. Rigging Length (whole numbers only): _____
- J. Seat to Floor Height (circle one): _____

Seating System	Low	Middle	Tall
Contoured Seating	22.5"	23.25"	24"
Specialty Seat	17.875"	18.625"	19.375"
Synergy® Seat	18.125"	19.125"	20.125"

Seat to floor height are +/- 1/8" with 18"W x 18"D with Flat-Free tires (add 3/8" for pneumatic tires). Increased widths may increase lowest seat to floor heights.

* While every effort will be taken to ensure dimensions will be preset to your specifications prior to shipping variations in options may effect final settings.

Notes:

DME providers are responsible for determining appropriate billing codes when submitting for insurance reimbursement. HCPCS codes should not be considered as legal advice. All prices are MSRP.

BASE MODEL		
Description	Price	HCPCS Code
<input type="checkbox"/> Quantum 1420 3SPHD-C	\$9,113	K0859
<input type="checkbox"/> Quantum 1420 3SPHD-SS	\$9,113	K0858
<input type="checkbox"/> Quantum 1420 3SPVHD-C	\$9,113	K0860

COLORS	
<input type="checkbox"/> Candy Apple Red	<input type="checkbox"/> Viper Blue
<input type="checkbox"/> Onyx Black	<input type="checkbox"/> Champagne
<input type="checkbox"/> Sunburst Orange	

MOTOR OPTIONS	
Description	Price
<input type="checkbox"/> High Torque Motor Package	Standard
<input type="checkbox"/> High Speed Motor Package ¹	\$1,574

Programmable Speed Up To 8 MPH, 450 lbs. Wt Capacity. HS Motors decrease per-charge range.

1. Requires Q-Logic EX.



BATTERY CHARGER	
Description	Price
<input type="checkbox"/> 8 Amp Off-board Charger	Standard

DRIVE WHEELS	
Description	Price
<input type="checkbox"/> 16" Flat-Free	Standard
<input type="checkbox"/> 16" Pneumatic	No Charge



CASTER WHEELS	
Description	Price
<input type="checkbox"/> 9" Flat-Free	\$105
<input type="checkbox"/> 9" Pneumatic	No Charge

POWER ELEVATE	
Description	Price
<input type="checkbox"/> Power Elevating Seat	\$975
<i>300 lbs. Weight Capacity, Maximum Seat Size 20"W x 20"D</i>	
<input type="checkbox"/> Through Toggle	
<input type="checkbox"/> Left Side	<input type="checkbox"/> Right Side
<input type="checkbox"/> Through VR2 6-Key	No Charge
<input type="checkbox"/> Through Q-Logic EX	(Choose Electronics for Power Options on page 5)

BASE MOUNTED FOOT PLATFORM	
Description	Price
<input type="checkbox"/> Base Mounted Foot Platform Installed	Standard
<input type="checkbox"/> No Base Mounted Foot Platform	No Charge

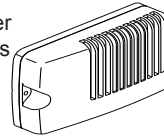
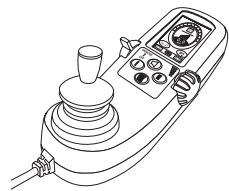
NON-EXPANDABLE CONTROLS	
Description	Price
<input type="checkbox"/> VR2 70 Amp 4-Key 	Standard
<input type="checkbox"/> VR2 70 Amp 6-Key 	\$200
	<i>Standard on 3SP-SS Package</i>

EXPANDABLE CONTROLS		
Description	Price	HCPCS Code
<i>Q-Logic EX Joystick or Enhanced Display must be ordered with a Q-Logic EX Controller and Harness For Expandable Controls</i>		
<input type="checkbox"/> 100 Amp Q-Logic EX Controller 	\$695	E2377
<input type="checkbox"/> Expandable Controller Harness	\$350	E2313
<input type="checkbox"/> Q-Logic EX Joystick 	\$700	

PROGRAMMING	
Description	Price
<input type="checkbox"/> Q-Logic Handheld Programmer 	\$545
<input type="checkbox"/> Q-Logic PC Programming Cable with Disk ¹	\$750
<input type="checkbox"/> PG Handheld Programmer 	\$750

1. Works with Q-Logic EX only.

JOYSTICK HANDLES		
Description	Price	HCPCS Code
<input type="checkbox"/> Standard Carrot Handle	Standard	
<input type="checkbox"/> Mushroom Handle	\$71	E2323
<input type="checkbox"/> T-Bar	\$107	E2323
<input type="checkbox"/> Chin Cup	\$71	E2324 ¹
<input type="checkbox"/> Extended I-Handle	\$71	E2323
<input type="checkbox"/> Soft Ball Handle	\$50	E2323
<input type="checkbox"/> Medium Ball Handle	\$50	E2323
<input type="checkbox"/> Bodypoint 3" Goal Post Handle	\$69	E2323
<input type="checkbox"/> Bodypoint 4" Goal Post Handle	\$69	E2323

1. Use HCPCS code E2323 when not used in conjunction with a chin control.

JOYSTICK MOUNTING BRACKETS		
Description	Price	HCPCS Code
<i>Comes Standard with a Quick Release, Adjustable-Height Joystick Block</i>		
<input type="checkbox"/> Fixed Inline ¹	Standard	
Side: <input type="checkbox"/> Left <input type="checkbox"/> Right		
<input type="checkbox"/> Swing-away	\$210	E1028
Side: <input type="checkbox"/> Left <input type="checkbox"/> Right		
Style: <input type="checkbox"/> Inline <input type="checkbox"/> Offset		
Length: <input type="checkbox"/> 4" Ext. <input type="checkbox"/> 7" Ext. ²		
<input type="checkbox"/> Multi-axis Fixed	\$100	K0108
Side: <input type="checkbox"/> Left <input type="checkbox"/> Right		

1. Not available with Q-Logic EX Stand Alone Joystick
2. In iQuantum choose in addition to Swing-Away 4" mount.

SYNERGY® BACK OPTIONS (CONT'D)

Description	Price
Tru Comfort Color Shroud Option:	
<input type="checkbox"/> Black (Standard color option)	
Metallic Colors:\$100	Solid Colors:\$100
<input type="checkbox"/> Champagne	<input type="checkbox"/> Mariner Blue
<input type="checkbox"/> Candy Apple Red	<input type="checkbox"/> Cardinal Red
<input type="checkbox"/> Viper Blue	<input type="checkbox"/> Spring Green
<input type="checkbox"/> Sunburst Orange	<input type="checkbox"/> Solar Yellow
<input type="checkbox"/> Pearl Pink	<input type="checkbox"/> Violet
<input type="checkbox"/> Silver	<input type="checkbox"/> Tangerine
<input type="checkbox"/> Pewter Gray	<input type="checkbox"/> Kelly Green
<input type="checkbox"/> Emerald Green	
<input type="checkbox"/> Graphite Blue	
<input type="checkbox"/> Sapphire Blue	
Synergy® Back Cane Options:	
<input type="checkbox"/> Standard Back Canes	Standard
<input type="checkbox"/> Omit Push Handles	\$125
<input type="checkbox"/> Offset (Meso) ¹	\$195
<input type="checkbox"/> 2" (1" Per Side) <input type="checkbox"/> 4" (2" Per Side)	
<input type="checkbox"/> Inset (Endo)	\$195
<input type="checkbox"/> 2" (1" Per Side) <input type="checkbox"/> 4" (2" Per Side)	

1. Dual Post Flip-back Armrests interfere with offset canes.

SYNERGY® ARMRESTS

Description	Price	HCPCS Code
<input type="checkbox"/> Flip-back, Cane Mounted ¹	No Charge	
<input type="checkbox"/> 2-post, Flip-back, Height-adjustable, Removable ^{2,3}	\$150 ea.	E0973
<input type="checkbox"/> Single-post, Height-adjustable, Removable ^{3,4}	\$75 ea.	E0973
<input type="checkbox"/> Quad Release Lever		
<input type="checkbox"/> Removable, Single-post, Height Adjustable, Heavy Duty	\$75 ea.	E0973
<input type="checkbox"/> 8"H - 12"H <input type="checkbox"/> 10"H-14"H		
<input type="checkbox"/> Pediatric, Removable ⁵	\$75 ea.	E0973
<i>Color:</i> <input type="checkbox"/> Match Shroud <input type="checkbox"/> Black		
<input type="checkbox"/> Quad Release Lever		
<input type="checkbox"/> Bariatric, Removable, Height Adjustable ⁶	\$75 ea.	E0973
<input type="checkbox"/> 8"H - 12"H <input type="checkbox"/> 10"H-14"H		
<input type="checkbox"/> Height Adjustable Cantilever Armrests ⁷	\$195	K0020
<i>Angle-Adjustable: -30° through +30°</i>		

1. Interferes with swing-away laterals.
 2. Interferes with swing-away laterals. Height adjustable from 9"-13" in 1" increments.
 3. Not available with a depth less than 14".
 4. Height adjustable from 11"-17" in 1/2" increments
 5. Height adjustable from 7.75"-9.75" in 1/2" increments. Full length armpads not available
 6. Bariatric Armrests require Bariatric Armpads
 7. Height adjustment from 11-17" depends on cane height. Not available with Manual Recline, Flip Forward back canes, Cane Clamp Pushbar, & Shape Back. Call for details when selecting aftermarket arm troughs or Universal Swivel.

SYNERGY® ARMPADS

Description	Price
<input type="checkbox"/> Straight, Full Length (2"x14")	Standard
<input type="checkbox"/> Left <input type="checkbox"/> Right	
<input type="checkbox"/> Straight, Desk Length (2"x10")	No Charge
<input type="checkbox"/> Left <input type="checkbox"/> Right	
<input type="checkbox"/> Waterfall, Full Length (2"x14") ¹	No Charge
<input type="checkbox"/> Left <input type="checkbox"/> Right	
<input type="checkbox"/> Waterfall, Desk Length (2"x10") ¹	No Charge
<input type="checkbox"/> Left <input type="checkbox"/> Right	
<input type="checkbox"/> Falcon Gel, Full Length, (3.5"x14") [*]	\$160 pr.
<input type="checkbox"/> Left <input type="checkbox"/> Right	
<input type="checkbox"/> Full Length Gel Armpad Mounting Plate (Required) [*]	\$56.69 ea.
<input type="checkbox"/> Falcon Gel, Desk Length, (3.5"x10") [*]	\$125 pr.
<input type="checkbox"/> Left <input type="checkbox"/> Right	
<input type="checkbox"/> Desk Length Gel Armpad Mounting Plate (Required) [*]	\$53.52 ea.
<input type="checkbox"/> Flat, Bariatric ²	No Charge
<input type="checkbox"/> Left <input type="checkbox"/> Right	

1. Not available w/ Cane Mounted, Flip Back Armrests combined with a Synergy Back.
 2. Bariatric Armrests require Bariatric Armpads

LAP BELTS

Description	Price
<input type="checkbox"/> 38" Lap Belt ¹	Standard
<input type="checkbox"/> 50" Lap Belt ¹	Standard
<input type="checkbox"/> 60" Lap Belt	Standard
<input type="checkbox"/> 70" Lap Belt	Standard
<input type="checkbox"/> 80" Lap Belt	Standard
<input type="checkbox"/> 90" Lap Belt	Standard
<input type="checkbox"/> Pelvic Positioning Belt, 2-Point Padded Med, 9"-15" Hip Width [*]	\$87
<input type="checkbox"/> Pelvic Positioning Belt, 2-Point Padded, Lg, 13"-19" Hip Width [*]	\$92
<input type="checkbox"/> Pelvic Positioning Belt, 4-Point Padded, Med, 9"-15" Hip Width [*]	\$112
<input type="checkbox"/> Pelvic Positioning Belt, 4-Point Padded, Lg, 13"-19" Hip Width [*]	\$116

1. Includes mounting hardware. Not available on Manual Recliner.

VENT TRAY (SYNERGY SEAT ONLY)

Description	Price
<input type="checkbox"/> Compact Vent Tray	\$1,395
<i>The addition of a compact vent tray may increase the length & weight of your power chair.</i>	
<i>Mounting Bracket:</i>	
<input type="checkbox"/> Flush <input type="checkbox"/> 3" Offset ¹ <input type="checkbox"/> 6" Offset	
<i>Bracket is pre-selected with TRU-Comfort Back</i>	
- Accomodates Pulmonetics LTV-style ventilators.	
- Max Vent Dim. 3.25" H x 10.5" W x 13.5" / 20 lbs.	
- Not Available with Shape Back or Sling Back.	
- Not available with rear mount accessories.	
- Not available on Synergy manual recline, Synergy manual tilt or with flip-down back canes.	

1. Not available with Cane Mounted Flip-up Arms.

LATERALS

Description	Price	HCPCS Code
<input type="checkbox"/> Stealth Thoracic Laterals (pair)[*]		
<i>Bracket:</i>		
<input type="checkbox"/> Swing-Away Rail Mount Bracket	\$450	E1028
<i>(For Use With Synergy Back and Tru Comfort Back)</i>		
<i>Choose Pad:</i>		
<input type="checkbox"/> Flat Pad, 3" x 5" Leather-Like Cover	\$200	E0956
<input type="checkbox"/> Flat Pad, 4" x 6" Leather-Like Cover	\$200	E0956
<input type="checkbox"/> Curved Pad, 2" x 3" 4-Way Stretch Cover	\$200	E0956
<input type="checkbox"/> Curved Pad, 3" x 5" 4-Way Stretch Cover	\$200	E0956
<input type="checkbox"/> Curved Pad, 4" x 6" 4-Way Stretch Cover	\$200	E0956
<input type="checkbox"/> Stealth Pelvic/Thigh Laterals[*]		
<i>Side(s):</i>		
<input type="checkbox"/> Left Side <input type="checkbox"/> Right Side		
<i>Choose Bracket:</i>		
<input type="checkbox"/> Removable Bracket (ea.)	\$250	E1028
<input type="checkbox"/> Removable Bracket w/ 1" Offset (ea.)	\$325	E1028
<input type="checkbox"/> Flip Down Bracket (ea.)	\$225	E1028
<i>Choose Pad:</i>		
<input type="checkbox"/> Short Pad, 4" x 4" (ea.)	\$90	E0956
<input type="checkbox"/> Medium Pad, 4" x 8" (ea.)	\$90	E0956
<input type="checkbox"/> Long Pad, 4" x 12" (ea.)	\$90	E0956
<i>Adapter:</i>		
<input type="checkbox"/> 2" Depth/Height Adapter Plate (ea.) ¹	\$25	K0108

1. Height adaper plate is needed w/ Tru Comfort seat cushion. Not available on the flip down bracket.

HEADRESTS

Description	Price	HCPCS Code
<input type="checkbox"/> No Headrest Required		
TRU-Comfort™ Headrest¹:		
<input type="checkbox"/> 8" W Leatherette	\$205	E0955
<input type="checkbox"/> 8"W TRU-Comfort Plus	\$205	E0955
<input type="checkbox"/> 10" W Leatherette	\$205	E0955
<input type="checkbox"/> 10"W TRU-Comfort Plus	\$205	E0955
<input type="checkbox"/> Removable Headrest Bracket	\$210	E1028

1. Measurement is taken from the inside of the headrest.

Items marked with a (*) should be chosen in the Positioning Components screen in iQuantum

HEADRESTS (CONT'D)		
Description	Price	HCPCS Code
Stealth:		
<input type="checkbox"/> Small (9.75"W x 3"H) (STL-OTSM250)	\$205	E0955
<input type="checkbox"/> Large (11"W x 6"H) (STL-OTLG150)	\$205	E0955
<input type="checkbox"/> Pediatric Comfort Plus (6"W) (CPN350)	\$142	E0955
<input type="checkbox"/> Small Comfort Plus (10"W) (CP250)	\$142	E0955
<input type="checkbox"/> Large Comfort Plus (14"W) (CP150)	\$142	E0955
<input type="checkbox"/> Removable Headrest Bracket ² (HMO475P)	\$210	E1028
<input type="checkbox"/> Swing-away (Flip-down) Headrest Bracket (FDM350) Used in Addition to Removable Headrest Bracket	\$210	
Aftermarket Bracket:		
<input type="checkbox"/> Stealth's World's Best Removable Headrest Hardware (TWB485)	\$210	E1028

MISCELLANEOUS POSITIONING COMPONENTS		
Description	Price	HCPCS Code
<input type="checkbox"/> Therafin Flip-down Knee Abductor Bracket ^{1*}	\$172	E1028
Pad:		
<input type="checkbox"/> Small <input type="checkbox"/> Medium <input type="checkbox"/> Large	\$135	E0957
<input type="checkbox"/> Stealth Foot Boxes (pair)*	\$475	K0108
<input type="checkbox"/> Small <input type="checkbox"/> Medium <input type="checkbox"/> Large		
<input type="checkbox"/> Stealth Padded Shoe Holders (pair)*	\$166	K0108
<input type="checkbox"/> Small <input type="checkbox"/> Medium <input type="checkbox"/> X-Large		
<input type="checkbox"/> Otto Bock Arm Channels (ea.)*	\$104	E2209
Side:		
<input type="checkbox"/> Left <input type="checkbox"/> Right		
Size:		
<input type="checkbox"/> Small <input type="checkbox"/> Medium <input type="checkbox"/> Large		
<input type="checkbox"/> Otto Bock Flat Hand Pad(ea.)*	\$52	
Side:		
<input type="checkbox"/> Left <input type="checkbox"/> Right		
Size:		
<input type="checkbox"/> Medium <input type="checkbox"/> Large		

Please see [positioning components order form](#) for additional types, sizes and details.

1. Not available with high mount foot platform.

NON-POWERED LEGRESTS		
Description	Price	HCPCS Code
<input type="checkbox"/> 70° Swing-away Legrests ¹	\$162	
<input type="checkbox"/> Straight <input type="checkbox"/> Tapered		
<input type="checkbox"/> 70° <input type="checkbox"/> 80°		
<input type="checkbox"/> Standard Extruded Footplates	No Charge	
Standard Extruded Extensions:		
<input type="checkbox"/> 11"-13" <input type="checkbox"/> 13"-16.5" <input type="checkbox"/> 15.5"-19.5" <input type="checkbox"/> 18.5"-122.5"		
Standard Extruded Footplates:		
<input type="checkbox"/> 7.25" x 6" <input type="checkbox"/> 8.5" x 6"		
<input type="checkbox"/> Angle-Adjustable Footplates ²	\$150	K0040
Angle Adjustable Extensions:		
<input type="checkbox"/> 11"-13" <input type="checkbox"/> 13"-16.5" <input type="checkbox"/> 15.5"-19.5" <input type="checkbox"/> 18.5"-122.5"		
Angle Adjustable Footplates:		
<input type="checkbox"/> 4" x 6" <input type="checkbox"/> 5" x 6" <input type="checkbox"/> 5" x 8"		
<input type="checkbox"/> 6" x 8" ³ <input type="checkbox"/> 6" x 11" ³ <input type="checkbox"/> 8" x 11" ⁴		
<input type="checkbox"/> Multi-Axis Footplates	\$495	K0040
Multi-Axis Extensions:		
<input type="checkbox"/> 11"-16.5" <input type="checkbox"/> 15.5"-19.5" <input type="checkbox"/> 18.5"-22.5"		
Multi-Axis Footplates:		
<input type="checkbox"/> 4" x 6" <input type="checkbox"/> 5" x 6" <input type="checkbox"/> 5" x 8"		
<input type="checkbox"/> 6" x 8" ³ <input type="checkbox"/> 6" x 11" ³ <input type="checkbox"/> 8" x 11" ⁴		
<input type="checkbox"/> High Mount, Clamp-On Footrest*		
<input type="checkbox"/> Angle Adjustable		K0040
<input type="checkbox"/> Small, 4" x 7.75"	\$356	
<input type="checkbox"/> Large, 4.25" x 9.25"	\$356	
<input type="checkbox"/> Multi-Axis		K0040
<input type="checkbox"/> Small, 4" x 7.75"	\$456	
<input type="checkbox"/> Large, 4.25" x 9.25"	\$460	

1. Legrest Extensions are measured from seatpan to footplate.
2. Includes Heel Loops
3. Causes interference on seat widths less than 18".
4. Causes interference on seat widths less than 20".

NON-POWERED LEGRESTS (CONT'D)		
Description	Price	HCPCS Code
<input type="checkbox"/> Heavy Duty Drop-In Legrests ⁵	\$420	
<input type="checkbox"/> 70° <input type="checkbox"/> 80°		
<input type="checkbox"/> Angle Adjustable Footplates ⁶	\$150	K0040
Angle Adjustable Extension Length:		
<input type="checkbox"/> 12"-14.5" <input type="checkbox"/> 14.5"-18" <input type="checkbox"/> 17.5"-21"		
Angle Adjustable Footplate Size:		
<input type="checkbox"/> 4" x 6" <input type="checkbox"/> 5" x 6" <input type="checkbox"/> 5" x 8"		
<input type="checkbox"/> 6" x 8" ⁷ <input type="checkbox"/> 6" x 11" ⁷ <input type="checkbox"/> 8" x 11" ⁸		
<input type="checkbox"/> Elevating Legrests	\$325	K0195/E0990 ⁹
<input type="checkbox"/> Standard Footplates		
Standard Extruded Extension Length:		
<input type="checkbox"/> 11"-14" <input type="checkbox"/> 14"-17"		
Standard Extruded Footplate Size:		
<input type="checkbox"/> 7.25" x 6" <input type="checkbox"/> 8.5" x 6"		
<input type="checkbox"/> Angle Adjustable Footplates ²	\$150	K0040
Angle Adjustable Extension Length:		
<input type="checkbox"/> 12"-14.5" <input type="checkbox"/> 14.5"-18"		
Angle Adjustable Footplate Size:		
<input type="checkbox"/> 4" x 6" <input type="checkbox"/> 5" x 6" <input type="checkbox"/> 5" x 8"		
<input type="checkbox"/> 6" x 8" ⁷ <input type="checkbox"/> 6" x 11" ⁷ <input type="checkbox"/> 8" x 11" ⁸		
<input type="checkbox"/> Calf Pad Adjustment		
<input type="checkbox"/> 1 Hole <input type="checkbox"/> 3 Hole <input type="checkbox"/> 6 Hole		

5. Legrest Extensions are measured from seatpan to footplate.
6. Includes heel loops.
7. Causes interference on seat widths less than 18".
8. Causes interference on seat widths less than 20".
9. E0990 code used for purchase in CBA. K0195 code used for capped rental.

ELECTRONICS FOR POWER FOOT PLATFORM		
Description	Price	HCPCS Code
<input type="checkbox"/> Single Actuator Through Q-Logic EX (PES Only)	\$1,175	
<input type="checkbox"/> Multiple Actuator Through Q-Logic EX	\$2,375	E2311

POWER ELEVATING LEGRESTS		
Description	Price	HCPCS Code
<input type="checkbox"/> 70° Articulating Swing-Away Legrests, 4" Articulation Range ¹	\$2,395	E1010
<input type="checkbox"/> Quad Release Lever		
Calf Pads ² :		
<input type="checkbox"/> 6" x 5.35" <input type="checkbox"/> 8" x 5.86"		
Angle Adjustable Extension Length ³ :		
<input type="checkbox"/> 11"-13" <input type="checkbox"/> 14.5"-18" <input type="checkbox"/> 17.5"-21"		
Angle Adjustable Footplate Size:		
<input type="checkbox"/> 4" x 6" <input type="checkbox"/> 5" x 6" <input type="checkbox"/> 5" x 8"		
<input type="checkbox"/> 6" x 8" ⁴ <input type="checkbox"/> 6" x 11" ⁴ <input type="checkbox"/> 8" x 11" ⁵		
Operational Method:		
<input type="checkbox"/> Independent <input type="checkbox"/> Combined		
<input type="checkbox"/> 70° Articulating Drop-In Legrests ¹	\$2,395	E1010
Angle:	<input type="checkbox"/> 70° <input type="checkbox"/> 80°	
Range:	<input type="checkbox"/> 4" Range <input type="checkbox"/> 6" Range	
Calf Pads ² :		
<input type="checkbox"/> 6" x 5.35" <input type="checkbox"/> 8" x 5.86"		
Angle Adjustable Extension Length ³ :		
<input type="checkbox"/> 12"-14.5" <input type="checkbox"/> 14.5"-18" <input type="checkbox"/> 17.5"-21"		
Angle Adjustable Footplate Size:		
<input type="checkbox"/> 4" x 6" <input type="checkbox"/> 5" x 6" <input type="checkbox"/> 5" x 8"		
<input type="checkbox"/> 6" x 8" ⁴ <input type="checkbox"/> 6" x 11" ⁴ <input type="checkbox"/> 8" x 11" ⁵		
Operational Method:		
<input type="checkbox"/> Independent <input type="checkbox"/> Combined		

1. Only available on Synergy Seating Systems.
2. Choose in Rigging Accessory Section in iQuantum.
3. Extensions are measured from top of seat pan to footplate.
4. Only available with seat width 18" or greater.
5. Only available with seat width 20" or greater.

Items marked with a (*) should be chosen in the Positioning Components screen in iQuantum

HIGH MOUNT FOOT PLATFORM

Description	Price	HCPCS Code
<input type="checkbox"/> Highmount Foot Platform ¹	\$450	K0108
<i>Extensions:</i>		
<input type="checkbox"/> 10"-14" Ext.		<input type="checkbox"/> 14"-17" Ext.
<i>Foot Platform Size²:</i>		
<input type="checkbox"/> 9.55"D		<input type="checkbox"/> 11.62"D

1. Extensions are measured from top of seat pan to footplate.

2. Custom Footplatform sizes are available through the Quantum Applications and Development Dept.

FRONT RIGGING ACCESSORIES

Description	Price	HCPCS Code
<input type="checkbox"/> Wheel Bumpers	\$25	
<input type="checkbox"/> Heel Loops (pair) ¹	\$38	E0951
<input type="checkbox"/> Gel Neoprene Footrest Sleeve (pair) ²	\$65	K0108
<input type="checkbox"/> ELR/ALR Adductor Buttons (pair)	\$125	K0108
<input type="checkbox"/> POSAlinc Knee Adductor for Swing-Away Legrests (pair)*	\$256	K0108
<input type="checkbox"/> POSAlinc Rail Mounted Knee Adductor (pair) *	\$287	K0108
<input type="checkbox"/> Residual Limb Support	\$300	E1020
<input type="checkbox"/> Bodypoint Ankle Huggers (pair)*	\$134	K0108
<input type="checkbox"/> Left		<input type="checkbox"/> Right
<input type="checkbox"/> Small		<input type="checkbox"/> Medium

1. Standard with Angle Adjustable or Multi-Axis footplates.

2. Only available with Swing-Away legrests.

SEAT CUSHIONS

Description	Price	HCPCS Code
<input type="checkbox"/> No Cushion Required		
<i>Please refer to Synergy order forms for detailed pricing, sizes and codes.</i>		
Simplicity Cushion <i>General Use</i>		
<input type="checkbox"/> 16" x 16" - 20" x 20"	\$98	E2601
<input type="checkbox"/> 22" x 16" - 24" x 24"	\$98	E2602
Solution® 1 Cushion <i>Skin Protection:</i>		
<input type="checkbox"/> 14" x 14" - 20" x 18"	\$380	E2603
<input type="checkbox"/> 20" x 20" - 20" x 24"	\$430	E2603
<input type="checkbox"/> 22" x 16" - 24" x 24"	\$430	E2604
Solution® Cushion <i>Skin Protection & Positioning</i>		
<input type="checkbox"/> 10" x 10" - 20" x 18"	\$380	E2607
<input type="checkbox"/> 20" x 20" - 20" x 24"	\$430	E2607
<input type="checkbox"/> 22" x 16" - 24" x 24"	\$430	E2608
Spectrum® Gel Cushion <i>Positioning</i>		
<input type="checkbox"/> 12" x 10" - 20" x 19"	\$480	E2605
<input type="checkbox"/> 20" x 20" - 20" x 22"	\$530	E2605
<input type="checkbox"/> 22" x 16" - 24" x 24"	\$530	E2606
Spectrum® Visco Cushion <i>Skin Protection & Positioning</i>		
<input type="checkbox"/> 10" x 10" - 20" x 18"	\$480	E2607
<input type="checkbox"/> 20" x 20" - 20" x 22"	\$530	E2607
<input type="checkbox"/> 22" x 16" - 24" x 24"	\$530	E2608
Spectrum® Air <i>Adjustable Skin Protection</i>		
<input type="checkbox"/> 14" x 12" - 20" x 20"	\$480	E2622
<input type="checkbox"/> 22" x 16" - 24" x 24"	\$530	E2623
Spectrum® Air Contour <i>Adjustable Skin Protection & Positioning</i>		
<input type="checkbox"/> 14" x 12" - 20" x 20"	\$499	E2624
<input type="checkbox"/> 22" x 16" - 24" x 24"	\$549	E2625
TRU-Comfort™ Seat Cushion <i>General Use</i>		
<i>Includes Allure leather-like cover</i>		
<input type="checkbox"/> 16" x 16" - 20" x 20"	\$380	E2601
<input type="checkbox"/> 22" x 16" - 22" x 24"	\$480	E2602
TRU-Comfort™ Plus Seat Cushion <i>Skin Protection</i>		
<i>Includes 4-way stretch material cover</i>		
<input type="checkbox"/> 16" x 16" - 20" x 20"	\$380	E2603
<input type="checkbox"/> 22" x 16" - 22" x 24"	\$480	E2604

ACCESSORIES

Description	Price	HCPCS Code
<input type="checkbox"/> Rear Basket ¹	\$103	
<input type="checkbox"/> Cane/Crutch Holder ¹	\$98	E2207
<input type="checkbox"/> Weather Cover, Medium, Black	\$158	
<input type="checkbox"/> Cup Holder	\$17 ²	
<i>Side:</i>		
<input type="checkbox"/> Left		<input type="checkbox"/> Right
<input type="checkbox"/> Saddle Bag	\$28	
<input type="checkbox"/> Flag Holder	\$17	
<input type="checkbox"/> Quantum Backpack ³	\$60	
<input type="checkbox"/> Oxygen Holder Contoured Seating ¹	\$103	E2208
<input type="checkbox"/> Oxygen Holder Synergy Seat ⁴	\$150	E2208
<input type="checkbox"/> Walker Holder ⁴	\$92	K0108
<input type="checkbox"/> Tablet Holder ⁵	\$315	
<input type="checkbox"/> Deluxe Cell Phone/Media Holder ⁵	\$140	
<input type="checkbox"/> Cell Phone/Media Holder ⁵	No Charge	

1. Includes mounting hardware. Not available on Manual Recliner.

2. No charge on Synergy Seating.

3. Backpack may interfere w/ other rear accessories. Not available w/ contoured seating.

4. Not available with Synergy manual recline or manual tilt. Includes mounting hardware.

5. Only available with Synergy or Specialty seating.

BATTERY OPTIONS

Description	Price	HCPCS Code
<input type="checkbox"/> Group 24, 70 Amp, Gel (<i>Universal</i>)	\$352 ea.	E2363
<input type="checkbox"/> Group 24, 70 Amp, Gel (<i>MK</i>)	\$352 ea.	E2363
<input type="checkbox"/> NF-22, 50-Amp Batteries		
<input type="checkbox"/> Maintenance Free AGM	\$255 ea.	E2361
<input type="checkbox"/> Maintenance Free Gel Cell (<i>Universal</i>)	\$295 ea.	E2361
<input type="checkbox"/> Maintenance Free Gel Cell (<i>MK</i>)	\$295 ea.	E2361
<i>Installation:</i>		
<input type="checkbox"/> Batteries Installed		<input type="checkbox"/> Do Not Install

Items marked with a (*) should be chosen in the Positioning Components screen in iQuantum