

Quantum® 600 Series

Group 3 Single Power & Multiple Power
Order Form
300 lbs. weight capacity



Quantum Rehab®

A Division of Pride Mobility Products Corporation®
182 Susquehanna Ave., Exeter, PA 18643
Phone: (866)800-2002 • Fax: (866) 707-3422

Account Number: _____

Provider Name: _____

Contact: _____

Phone: _____

Fax: _____

Date: _____

PO#: _____

Marked For: _____

Ship To: _____

Address: _____

City: _____ State: _____ Zip: _____

Discount: _____

Terms: _____

Freight: _____

Taken By: _____

SET-TO-SPEC*

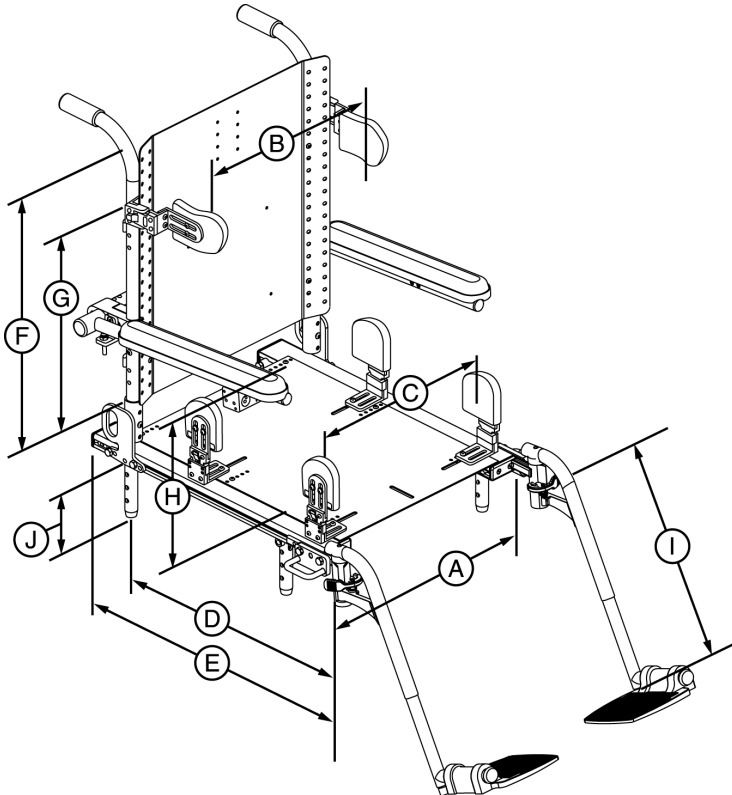

Please Supply Client Information:

Client Height: _____

Client Weight: _____

A. Seat Width: _____

B. Lateral Offset: _____

C. Hip/Thigh Lateral Offset: _____

D. Center of Gravity: Optimized based on seat dimensions

E. Seat Depth: _____

F. Back Height from Pan: _____

G. Lateral Height from Pan: _____

H. Armrest Height from Pan: _____

I. Rigging Length (whole numbers only): _____

J. Seat to Floor Height (circle one): _____

Seating System	Seat-To-Floor Heights			
	18.125"	19.125"	20.125"	21.125"
TRU-Balance® Tilt or Tilt & Recline	18.125"	19.125"	20.125"	21.125"
TRU-Balance® Recline	17"	18"	19"	
TRU-Balance® Lift	19.25"	20.125"	21"	21.875"

*Seat to floor height are +/- 1/8" with 18"W x 18"D with Flat-Free tires (add 3/8" for pneumatic tires).
Increased widths may increase lowest seat to floor heights.*

* While every effort will be taken to ensure dimensions will be preset to your specifications prior to shipping variations in options may effect final settings.

Notes:

DME providers are responsible for determining appropriate billing codes when submitting for insurance reimbursement. HCPCS codes should not be considered as legal advice. All prices are MSRP. Options with a circular checkbox (⊙) NOT available through Quantum West.

BASE MODEL **NON-EXPANDABLE CONTROLS**

Description	Price	HCPCS Code
<input type="checkbox"/> Quantum 600 3SP-SS	\$6,321	K0856
<input type="checkbox"/> Quantum 600 3MP-SS	\$6,121	K0861

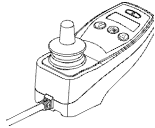
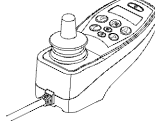
Description	Price
<input type="checkbox"/> 75 Amp NE 	Standard
<input type="checkbox"/> 75 Amp NE+ 6-Key For Up To 2 Actuators Thru Joystick 	\$200 <i>Standard on 3SP-SS Package</i>

COLORS

Metallic Colors:

- Candy Apple Red
- Viper Blue
- Onyx Black
- Sunburst Orange
- Pearl Pink
- Silver
- Emerald Green
- Sapphire Blue

EXPANDABLE CONTROLS

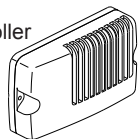
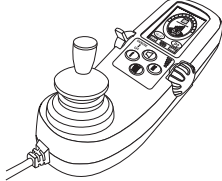
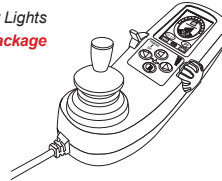
Description	Price	HCPCS Code
<i>Q-Logic EX Joysticks or Enhanced Display Must Be Ordered With Q-Logic EX Controller and Harness For Expandable Controller</i>		
<input type="checkbox"/> 100 Amp Q-Logic EX Controller	\$695	E2377
<input type="checkbox"/> Harness For Expandable Controller 	\$350	E2313
<input type="checkbox"/> Q-Logic EX Joystick 	\$700	
<input type="checkbox"/> Q-Logic EX Joystick For Lights 	\$700	<i>Required For LED Light Package</i>

MOTOR OPTIONS

Description	Price	HCPCS Code
<input type="checkbox"/> Standard Motor Package	Standard	
<input type="checkbox"/> High Speed Motor Package	\$1,574	
<i>Programmable Speed Up To 6 MPH, 300 lbs. Wt. Capacity. HS Motors decrease per-charge range.</i>		
<input type="checkbox"/> Accu-Trac Motor Technology ¹	\$1,295	K0108
<i>Delivers Enhanced Traction and Tracking Especially With Switched Drive Controls</i>		
<input type="checkbox"/> Community Use Package ²	\$2,125	
<u>Package Includes:</u>		
- 300 lbs. Weight Capacity		
- 4-Pole High Speed Motor Package		
- 4" Wide Flat Free, Knobby, Extended Traction Tires		

1. Requires Q-Logic EX.
2. Increases overall base width by 1.5".

BASE MOUNTED FOOT PLATFORM

Description	Price
<input type="checkbox"/> Base Mounted Foot Platform	Standard
<input type="checkbox"/> Omit Base Mounted Foot Platform	No Charge

DRIVE WHEELS

Description	Price
<input type="checkbox"/> 14" Flat-Free	Standard
<input type="checkbox"/> 14" Pneumatic	No Charge
<input type="checkbox"/> 4" Wide Flat Free, Knobby, Extended-Traction Tires ¹	\$551
<input type="checkbox"/> 4" Wide Pneumatic, Knobby, Extended-Traction Tires ¹	\$551

1. Increases overall base width by 1.5" with Flat Free, 1.8" with Pneumatic.

BATTERY CHARGER

Description	Price
<input type="checkbox"/> 8 Amp Off-board Charger	Standard

LED LIGHT PACKAGE

Description	Price
<input type="checkbox"/> Through Q-Logic EX w/ Lights	\$995

TRANSIT KIT

Description	Price
<input type="checkbox"/> Unoccupied Transit Kit ¹	No Charge

1. Unoccupied Transit Kit with a Vent Tray may not allow lowest seat to floor height.

PROGRAMMING

Description	Price
<input type="checkbox"/> Q-Logic Handheld Programmer 	\$545
<input type="checkbox"/> Q-Logic Programming Cable w/ Disk ¹	\$750

1. Works with Q-Logic EX only

JOYSTICK HANDLES

Description	Price	HCPCS Code
<input type="checkbox"/> Standard Carrot Handle	Standard	
<input type="checkbox"/> Mushroom Handle	\$71	E2323
<input type="checkbox"/> T-Bar	\$107	E2323
<input type="checkbox"/> Chin Cup	\$71	E2324 ¹
<input type="checkbox"/> Extended I-Handle	\$71	E2323
<input type="checkbox"/> Soft Ball Handle	\$50	E2323
<input type="checkbox"/> Medium Ball Handle	\$50	E2323
<input type="checkbox"/> Bodypoint 3" Goal Post Handle	\$69	E2323
<input type="checkbox"/> Bodypoint 4" Goal Post Handle	\$69	E2323

1. Use HCPCS code E2323 when not used in conjunction with a chin control.

Options with a circular checkbox (○) are NOT available through Quantum West.

JOYSTICK MOUNTING BRACKETS

BACK OPTIONS (CONT'D)

Description	Price	HCPCS Code
<i>Comes Standard with a Quick Release, Adjustable-Height Joystick Block</i>		
<input type="checkbox"/> Fixed Inline ¹	Standard	
Side: <input type="checkbox"/> Left <input type="checkbox"/> Right		
<input type="checkbox"/> Swing-away	\$210	E1028
Side: <input type="checkbox"/> Left <input type="checkbox"/> Right		
Style: <input type="checkbox"/> Inline <input type="checkbox"/> Offset		
Length: <input type="checkbox"/> 4" Ext. <input type="checkbox"/> 7" Ext. ²		
<input type="checkbox"/> Multi-axis Fixed	\$100	K0108
Side: <input type="checkbox"/> Left <input type="checkbox"/> Right		

1. Not available with Q-Logic EX Stand Alone Joystick
2. In iQuantum choose in addition to Swing-Away 4" mount.

TRU-BALANCE® POWER POSITIONING

Description	Price	HCPCS Code
<input type="checkbox"/> TRU-Balance® Power Tilt (55°)	\$4,995	E1002
<i>55 degree center of gravity (CG) power tilt seating system</i>		
<input type="checkbox"/> TRU-Balance® Power Recline (168°)	\$5,595	E1004
<i>168 degrees of power recline with full drive lock-out set at 20 degrees</i>		
<input type="checkbox"/> TRU-Balance® Power Tilt (55°) & Recline (168°)	\$9,595	E1007
<i>55 degree center of gravity (CG) power tilt seating system with 168 degrees of power recline Full drive lock-out at 20 degrees</i>		
<input type="checkbox"/> TRU-Balance® Lift (10") ¹	\$2,895	
<i>Must be selected in conjunction with TB Power Tilt or TB Power Tilt & Recline Maximum seat size of 20"W x 20"D</i>		

1. 10" of scissor Lift, must select TB Tilt or TB Tilt & Recline in conjunction with lift, 1/4 Speed Inhibit, 300 lbs. max. wt., Allowable dimensions 16" x 16" - 20" x 20", Requires Q-Logic EX, Not available with Manual Recline or Power Recline Only.

New Design!

SEATING SPECIFICATIONS

Seat Width:
 14" 15" 16" 17" 18" 19" 20"

Seat Width Packages:
 14"W-18"W 15"W-20"W

Seat Depth:
 14" 15" 16" 17" 18" 19" 20"

Seat Depth Package:
 14"D-18"D 15"D-20"D

Back Cane Height:
 14" 15" 16" 17" 18"
 19" 20" 21" 22" 23"
 24" 25"

BACK OPTIONS

Description	Price	HCPCS Code
Tilt Back:		
<input type="checkbox"/> Synergy® Shape Back Positioning Back	Various	E2613/E2614
<i>See Synergy Shape Back Order Form For Detailed Pricing, Sizes and Codes</i>		
<input type="checkbox"/> Omit Back	No Charge	
<input type="checkbox"/> Synergy® Back with 1.5" Thick Back Cushion	No Charge	
Overall Back <input type="checkbox"/> 18" H <input type="checkbox"/> 19" H <input type="checkbox"/> 20" H <input type="checkbox"/> 21" H		
Height: <input type="checkbox"/> 22" H <input type="checkbox"/> 23" H <input type="checkbox"/> 24" H <input type="checkbox"/> 25" H		
<i>Choose Lateral Extensions:</i>		
<input type="checkbox"/> 6" for 13"-16"H Back	\$25	
<input type="checkbox"/> 10" for 17"-18"H Back	\$25	
<input type="checkbox"/> 12" For 19"-22"H Back	\$25	
<input type="checkbox"/> 16" For 23"-25"H Back	\$25	
TRU-Comfort™ Back 4-way Stretch Material Cover		
Width: <input type="checkbox"/> 16"W <input type="checkbox"/> 18" W <input type="checkbox"/> 20"W	\$595	E2620
Overall Back <input type="checkbox"/> 20" H <input type="checkbox"/> 21" H <input type="checkbox"/> 22" H <input type="checkbox"/> 23" H		
Height ¹ : <input type="checkbox"/> 24" H <input type="checkbox"/> 25" H <input type="checkbox"/> 27" H <input type="checkbox"/> 28" H		
Width: <input type="checkbox"/> 17"W <input type="checkbox"/> 19"W	\$595	E2620
Overall Back <input type="checkbox"/> 22" H <input type="checkbox"/> 23" H <input type="checkbox"/> 24" H <input type="checkbox"/> 25" H		
Height ¹ : <input type="checkbox"/> 27" H <input type="checkbox"/> 28" H		
Width: <input type="checkbox"/> 22"W ² <input type="checkbox"/> 24"W ²	\$695	E2621
Overall Back <input type="checkbox"/> 24" H <input type="checkbox"/> 25" H <input type="checkbox"/> 27" H <input type="checkbox"/> 28" H		
Height ¹ :		

1. Overall Back height measurement is measured from the seat pan to the top of the back, +/- 1/2".
2. Available with offset (meso) brackets.

Description	Price	HCPCS Code
Tru Comfort Color Shroud Option:		
<input type="checkbox"/> Black (Standard color option)		
Metallic Colors:\$100		
<input type="radio"/> Candy Apple Red	<input type="radio"/> Silver	
<input type="radio"/> Viper Blue	<input type="radio"/> Emerald Green	
<input type="radio"/> Sunburst Orange	<input type="radio"/> Sapphire Blue	
<input type="radio"/> Pearl Pink		
Tilt Back Options:		
<input type="checkbox"/> Standard Back Canes	Standard	
<input type="checkbox"/> Omit Push Handles	\$125	
<input type="checkbox"/> Flip Forward Back Canes ³	\$150	
<input type="checkbox"/> Omit Push Handles	\$125	
<input type="checkbox"/> Offset (Meso) ⁴	\$195	
<input type="checkbox"/> 2" (1" Per Side) <input type="checkbox"/> 4" (2" Per Side)		
<input type="checkbox"/> Inset (Endo) ⁴	\$195	
<input type="checkbox"/> 2" (1" Per Side) <input type="checkbox"/> 4" (2" Per Side)		
<input type="checkbox"/> Attendant Manual Recline ⁵	\$750	E1226

Power Recline Back:

<input type="checkbox"/> Synergy® Reclining Back with 1.5" Thick Back Cushion	Standard	
TRU-Comfort™ Back 4-way Stretch Material Cover		
Width: <input type="checkbox"/> 16"W <input type="checkbox"/> 17" W <input type="checkbox"/> 18"W	\$595/\$795	E2620
<input type="checkbox"/> 19"W <input type="checkbox"/> 20"W		
<input type="checkbox"/> 22"W ⁶	\$695/\$795	E2621
Overall Back <input type="checkbox"/> 20" H <input type="checkbox"/> 21" H <input type="checkbox"/> 22" H <input type="checkbox"/> 23" H		
Height ⁷ : <input type="checkbox"/> 24" H <input type="checkbox"/> 25" H <input type="checkbox"/> 27" H <input type="checkbox"/> 28" H		
<input type="checkbox"/> After-Market Back Interface ⁸	\$200	

Recline Back Options:

<input type="checkbox"/> Offset (Meso) ⁹	\$195	
<input type="checkbox"/> 2" (1" Per Side) <input type="checkbox"/> 4" (2" Per Side)		
<input type="checkbox"/> Inset (Endo) ⁹	\$195	
<input type="checkbox"/> 2" (1" Per Side) <input type="checkbox"/> 4" (2" Per Side)		

Recline Color Shroud Option:

<input type="checkbox"/> Black (Standard color option)		
Metallic Colors:N/C		
<input type="checkbox"/> Candy Apple Red	<input type="checkbox"/> Silver	
<input type="checkbox"/> Viper Blue	<input type="checkbox"/> Emerald Green	
<input type="checkbox"/> Sunburst Orange	<input type="checkbox"/> Sapphire Blue	
<input type="checkbox"/> Pearl Pink		

3. Not available with Attendant Manual Recline, Vent Tray, or O2 Holder. May interfere with Lateral Supports and Waterfall Armpads.
4. Dual Post Flip-back Armrests interfere with offset canes. Not available with Manual Recline.
5. Not available with Flip Back Arms, Cantilever Arms, Shape Back, Tru Comfort back, power elevating seat or 10" Lift. Requires 22"H canes. Pivot point 2.5" above seat pan.
6. Available with offset (meso) brackets.
7. Overall Back height measurement is measured from the seat pan to the top of the back. All back heights except 25" and 28" are SOF with no extended lead time.
8. Overall Seat depth may need to be adjusted to accommodate certain backs. Contact your Quantum Specialist for details. Does not include brackets to mount after market back.
9. Requires Cantilever Arms. Back width can not be less than 14" or greater than 24".

Options with a circular checkbox (☐) are NOT available through Quantum West.

ARMRESTS		HEADRESTS		
Description	Price	Description	Price	HCPCS Code
Tilt Armrests:		<input type="checkbox"/> No Headrest Required		
<input type="checkbox"/> Flip Back, Cane Mounted Armrests ¹	No Charge	TRU-Comfort™ Headrest¹:		
<input type="checkbox"/> 2-Post, Flip-back, Height Adjustable, Removable ²	No Charge	<input type="checkbox"/> 8" W Leatherette	\$205	E0955
<input type="checkbox"/> Single Post Height Adjustable Removable ³	No Charge	<input type="checkbox"/> 8"W TRU-Comfort Plus	\$205	E0955
<input type="checkbox"/> Quad Release Lever		<input type="checkbox"/> 10" W Leatherette	\$205	E0955
<input type="checkbox"/> Removable, Single Post, Height Adjustable, Heavy Duty	No Charge	<input type="checkbox"/> 10"W TRU-Comfort Plus	\$205	E0955
Height: <input type="checkbox"/> 8"H - 12"H <input type="checkbox"/> 10"H - 14"H		<input type="checkbox"/> Removable Headrest Bracket	\$210	E1028
<input type="checkbox"/> Pediatric, Removable ⁴	No Charge	Stealth:		
Color: <input type="checkbox"/> Black <input type="checkbox"/> Match Shroud		<input type="checkbox"/> Small (9.75"W x 3"H) (STL-OTSM250)	\$205	E0955
<input type="checkbox"/> Quad Release Lever		<input type="checkbox"/> Large (11"W x 6"H) (STL-OTLG150)	\$205	E0955
<input type="checkbox"/> Height Adjustable Cantilever Armrests ⁵	\$195	<input type="checkbox"/> Pediatric Comfort Plus (6"W) (CPN350)	\$142	E0955
Angle Adjustable: -30° through +30°		<input type="checkbox"/> Small Comfort Plus (10"W) (CP250)	\$142	E0955
Power Recline Armrests:		<input type="checkbox"/> Large Comfort Plus (14"W) (CP150)	\$142	E0955
<input type="checkbox"/> Reclining, Flip Back	Standard	<input type="checkbox"/> Removable Headrest Bracket ² (HMO475P)	\$210	E1028
Height: <input type="checkbox"/> 8"H - 9"H <input type="checkbox"/> 10"H - 11"H		<input type="checkbox"/> Swing-away (Flip-down) Headrest	\$210	
<input type="checkbox"/> Height Adjustable Cantilever Armrests ¹	\$195	Bracket ² (FDM350)		
Angle Adjustable: -30° through +30°		Used in Addition to Removable Headrest Bracket		
1. Interferes with Swing-Away laterals.		Medical Applications:		
2. Height adjustment from 9"-13" in 1" increments. Interferes with swing-away laterals. Not available with a depth less than 15".		<input type="checkbox"/> Reclining Headrest (6.5"W x 7"H)	\$205	E0955
3. Height adjustable from 11" - 17" in 1/2" increments.		<input type="checkbox"/> Removable Bracket For Reclining Headrest	\$210	E1028
4. Height adjustment from 7.75" - 9.75" in 1/2" increments. Not available with full length arm pads.		Aftermarket Bracket:		
5. Height adjustment from 11"-17" depends on cane height. Not available with Manual Recline, Flip Forward Back Canes, Cane Clamp Pushbar, or Shape Back. Call for details when selecting after market arm troughs.		<input type="checkbox"/> Stealth's World's Best Removable Headrest	\$210	E1028
		Hardware (TWB485)		
		1. Measurement is taken from the inside of the headrest.		
		2. Not available with power recline.		

ARMPADS		NON-POWER LEGRESTS		
Description	Price	Description	Price	HCPCS Code
<input type="checkbox"/> Straight, Full Length (2"x14")	Standard	<input type="checkbox"/> 70° Swing-away Legrests ¹	Standard	
<input type="checkbox"/> Left <input type="checkbox"/> Right		<input type="checkbox"/> Straight <input type="checkbox"/> Tapered		
<input type="checkbox"/> Straight, Desk Length (2"x10")	No Charge	<input type="checkbox"/> Standard Extruded Footplates	No Charge	
<input type="checkbox"/> Left <input type="checkbox"/> Right		Standard Extruded Extensions:		
<input type="checkbox"/> Waterfall, Full Length (2"x14") ¹	No Charge	<input type="checkbox"/> 11"-13" <input type="checkbox"/> 13"-16.5" <input type="checkbox"/> 15.5"-19.5"		
<input type="checkbox"/> Left <input type="checkbox"/> Right		Standard Extruded Footplates:		
<input type="checkbox"/> Waterfall, Desk Length (2"x10") ¹	No Charge	<input type="checkbox"/> 7.25" x 6" <input type="checkbox"/> 8.5" x 6"		
<input type="checkbox"/> Left <input type="checkbox"/> Right		<input type="checkbox"/> Angle-Adjustable Footplates ²	\$150	K0040
<input type="checkbox"/> Falcon Gel, Full Length, (3.5"x14")*	\$160 pr.	Angle Adjustable Extensions:		
<input type="checkbox"/> Left <input type="checkbox"/> Right		<input type="checkbox"/> 11"-13" <input type="checkbox"/> 13"-16.5" <input type="checkbox"/> 15.5"-19.5"		
<input type="checkbox"/> Full Length Gel Armpad	\$56.69 ea.	Angle-Adjustable Footplates:		
Mounting Plate (Required)*		<input type="checkbox"/> 4" x 6" <input type="checkbox"/> 5" x 6" <input type="checkbox"/> 5" x 8"		
<input type="checkbox"/> Falcon Gel, Desk Length, (3.5"x10")*	\$125 pr.	<input type="checkbox"/> 6" x 8" ³ <input type="checkbox"/> 6" x 11" ³ <input type="checkbox"/> 8" x 11" ⁴		
<input type="checkbox"/> Left <input type="checkbox"/> Right		<input type="checkbox"/> Multi-Axis Footplates	\$495	K0040
<input type="checkbox"/> Desk Length Gel Armpad	\$53.52 ea.	Multi-Axis Extensions:		
Mounting Plate (Required)*		<input type="checkbox"/> 11"-16.5" <input type="checkbox"/> 15.5"-19.5"		
1. Not available w/ Cane Mounted, Flip Back Armrests combined with a Synergy Back.		Multi-Axis Footplates:		
		<input type="checkbox"/> 4" x 6" <input type="checkbox"/> 5" x 6" <input type="checkbox"/> 5" x 8"		
		<input type="checkbox"/> 6" x 8" ³ <input type="checkbox"/> 6" x 11" ³ <input type="checkbox"/> 8" x 11" ⁴		

POWER POSITIONING ELECTRONICS			
Description	Price	HCPCS Code	
Single Actuator Electronics:			
<input type="checkbox"/> Through Toggle Box (Tilt Only)	No Charge		
<input type="checkbox"/> Left Mount <input type="checkbox"/> Right Mount			
<input type="checkbox"/> Through NE+ 6-Key	\$1175	E2310	
<input type="checkbox"/> Through Single Switch ¹ (Tilt Only with Q-Logic EX)	\$500		
<input type="checkbox"/> Through Q-Logic EX Controller	\$1175	E2310	
Dual Actuator Electronics:			
<input type="checkbox"/> Through NE+ 6-Key Controller	\$2375	E2311	
Multiple Actuator Electronics:			
<input type="checkbox"/> Through Q-Logic EX Controller	\$2,375	E2311	
<input type="checkbox"/> Q-Logic EX Through 4-Way Toggle	\$2,375		
<input type="checkbox"/> Left Mount <input type="checkbox"/> Right Mount			
<input type="checkbox"/> Q-Logic EX Through 4-Way Button Toggle	\$2,375		
<input type="checkbox"/> Left Mount <input type="checkbox"/> Right Mount			
<input type="checkbox"/> Q-Logic EX Through Quad Push-button	\$2,375		
<input type="checkbox"/> Left Mount <input type="checkbox"/> Right Mount			
1. Single switch not included. See specialty controls order form for a list of available switches.			

<input type="checkbox"/> High Mount, Clamp-On Footrest*			
<input type="checkbox"/> Angle Adjustable			K0040
<input type="checkbox"/> Small, 4" x 7.75"	\$356		
<input type="checkbox"/> Large, 4.25" x 9.25"	\$356		
<input type="checkbox"/> Multi-Axis			K0040
<input type="checkbox"/> Small, 4" x 7.75"	\$456		
<input type="checkbox"/> Large, 4.25" x 9.25"	\$460		
<input type="checkbox"/> Heavy Duty Drop-In Legrests ¹	\$420		
<input type="checkbox"/> Angle Adjustable Footplates ²	\$150		K0040
Angle Adjustable Extension Length:			
<input type="checkbox"/> 12"-14.5" <input type="checkbox"/> 14.5" -18"			
Angle Adjustable Footplate Size:			
<input type="checkbox"/> 4" x 6" <input type="checkbox"/> 5" x 6" <input type="checkbox"/> 5" x 8"			
<input type="checkbox"/> 6" x 8" ³ <input type="checkbox"/> 6" x 11" ³ <input type="checkbox"/> 8" x 11" ⁴			
1. Legrest Extensions are measured from seatpan to footplate.			
2. Includes Heel Loops			
3. Causes interference on seat widths less than 18".			
4. Causes interference on seat widths less than 20".			

Items marked with a (*) should be chosen in the Positioning Components screen in iQuantum

Options with a circular checkbox (☐) are NOT available through Quantum West.

NON-POWERED LEGRESTS (CONT'D)

POWERED LEGRESTS

Description	Price	HCPCS Code
<input type="checkbox"/> Elevating Legrests¹	\$325	E0990
☐ Standard Footplates Standard Extruded Extension Length: ☐ 11"-14" ☐ 14"-17"		
☐ Angle Adjustable Footplates ²	\$150	K0040
Standard Extruded Footplate Size: ☐ 7.25" x 6" ☐ 8.5" x 6"		
Angle Adjustable Extension Length: ☐ 12"-14.5" ☐ 14.5" -18"		
Angle Adjustable Footplate Size: ☐ 4" x 6" ☐ 5" x 6" ☐ 5" x 8" ☐ 6" x 8" ³ ☐ 6" x 11" ⁷ ☐ 8" x 11" ⁴		
☐ Calf Pad Adjustment ☐ 1 Hole ☐ 3 Hole ☐ 6 Hole		
<input type="checkbox"/> 90° Pediatric Swing-Away Legrests⁵	\$162	
☐ Angle Adjustable Footplates ⁶		
Angle Adjustable Extension Length: ☐ 7"-10"		
Angle Adjustable Footplate Size: ☐ 4" x 6" ☐ 5" x 6"		

- Extensions are measured from the seatpan to footplate.
- Includes heel loops.
- Causes interference on seat widths less than 18".
- Causes interference on seat widths less than 20".
- Extensions are measured from the seatpan to footplate.
- Includes heel loops.

Description	Price	HCPCS Code
<input type="checkbox"/> 70° Articulating Swing-Away Legrests, 4" Articulation Range	\$2,395	E1010
☐ Quad Release Lever		
Calf Pads ¹ : ☐ 6" x 5.35" ☐ 8" x 5.86"		
Angle Adjustable Extension Length ² : ☐ 11"-13" ☐ 14.5"-18"		
Angle Adjustable Footplate Size: ☐ 4" x 6" ☐ 5" x 6" ☐ 5" x 8" ☐ 6" x 8" ³ ☐ 6" x 11" ³ ☐ 8" x 11" ⁴		
Operational Method: ☐ Independent ☐ Combined		
<input type="checkbox"/> 70° Articulating Drop-In Legrests	\$2,395	E1010
☐ 4" Range ☐ 6" Range		
Calf Pads ¹ : ☐ 6" x 5.35" ☐ 8" x 5.86"		
Angle Adjustable Extension Length ² : ☐ 12"-14.5" ☐ 14.5"-18"		
Angle Adjustable Footplate Size: ☐ 4" x 6" ☐ 5" x 6" ☐ 5" x 8" ☐ 6" x 8" ³ ☐ 6" x 11" ³ ☐ 8" x 11" ⁴		
Operational Method: ☐ Independent ☐ Combined		

- Choose in Rigging Accessory Section in iQuantum.
- Extensions are measured from top of seat pan to footplate.
- Only available with seat width 18" or greater.
- Only available with seat width 20" or greater.

New!!!

New!!!

ADJUSTABLE CENTER MOUNT FOOT PLATFORM

CENTER MOUNT ARTICULATING FOOT PLATFORM

Description	Price
<input type="checkbox"/> Adjustable Center Mount Foot Platform	\$250
Includes 10"W x 11"D Split Foot Platform	
Extensions: ¹ ☐ 10"-16" Ext. ☐ 13"-19" Ext.	
Calf Supports ² :	
☐ Calf Pads (pair)	\$150
☐ Small (6"H x 6"W)	
☐ Large (8"H x 8"W, Tapered to 6"W)	
Optional Modular Footplate Extension Components/Kits ^{2,3}	
☐ 4" Width Extension Kit	\$50
☐ 2" Bell Shaped, Length Extension Kit	\$50
☐ 4" Width Extension with 2" Bell Shaped, Length Extension Kit	\$75
☐ 6-Piece Extension Stock Kit (Includes all above pieces)	\$95
Additional Optional Accessories ² :	
☐ Footplate Connector	\$49

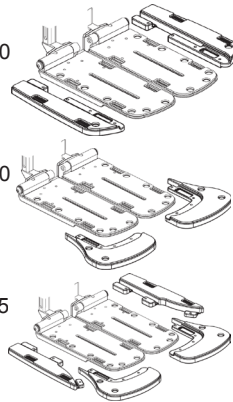

Description	Price	HCPCS Code
<input type="checkbox"/> Center Mount Articulating Foot Platform	\$2895	K0108
Includes 10"W x 11"D Split Foot Platform		
Extensions: ¹ ☐ 10"-16" Ext. ☐ 13"-19" Ext.		
Calf Supports ² :		
☐ Calf Pads (pair)		
☐ Small (6"H x 6"W)		
☐ Large (8"H x 8"W, Tapered to 6"W)		
Optional Modular Footplate Extension Components/Kits ^{2,3}		
☐ 4" Width Extension Kit	\$50	
☐ 2" Bell Shaped, Length Extension Kit	\$50	
☐ 4" Width Extension with 2" Bell Shaped, Length Extension Kit	\$75	
☐ 6-Piece Extension Stock Kit (Includes all above pieces)	\$95	
Additional Optional Accessories ² :		
☐ Footplate Connector	\$49	

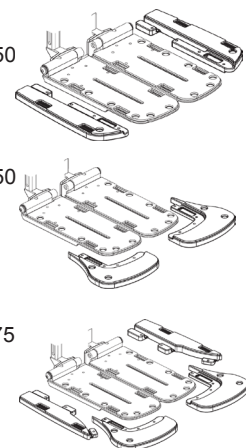

- Extension length is measured from top of the seat pan to footplate.
- Choose in Rigging Accessory Section in iQuantum.
- Assembly required. May require seating configuration adjustments to avoid front caster interference.

- Extension length is measured from top of the seat pan to footplate.
- Choose in Rigging Accessory Section in iQuantum.
- Assembly required. May require seating configuration adjustments to avoid front caster interference.

Options with a circular checkbox (○) are NOT available through Quantum West.

FRONT RIGGING ACCESSORIES

Description	Price	HCPCS Code
<input type="checkbox"/> Wheel Bumpers	\$25	
<input type="checkbox"/> Heel Loops (pair) ¹	\$38	E0951
<input type="checkbox"/> Gel Neoprene Footrest Sleeve (pair) ²	\$65	K0108
<input type="checkbox"/> ELR/ALR Adductor Buttons (pair)	\$125	K0108
<input type="checkbox"/> POSAlinc Knee Adductor for Swing-Away Legrests (pair)*	\$256	K0108
<input type="checkbox"/> POSAlinc Rail Mounted Knee Adductor (pair)*	\$287	K0108
<input type="checkbox"/> Residual Limb Support	\$300	E1020
<input type="checkbox"/> Left <input type="checkbox"/> Right		
<input type="checkbox"/> Bodypoint Ankle Huggers (pair)*	\$134	K0108
<input type="checkbox"/> Small <input type="checkbox"/> Medium		

1. Standard with angle adjustable footplates.
2. Available only with swing-away legrests.

SYNERGY® CUSHIONS

Description	Price	HCPCS Code
<input type="checkbox"/> No Cushion Required		
<i>Please refer to Synergy order forms for detailed pricing, sizes and codes.</i>		
Simplicity Cushion <i>General Use</i>		
<input type="checkbox"/> 16" x 16" - 20" x 20"	\$98	E2601
Solution® 1 Cushion <i>Skin Protection:</i>		
<input type="checkbox"/> 14" x 14" - 20" x 18"	\$380	E2603
<input type="checkbox"/> 20" x 20"	\$430	E2603
Solution® Cushion <i>Skin Protection & Positioning</i>		
<input type="checkbox"/> 10" x 10" - 20" x 18"	\$380	E2607
<input type="checkbox"/> 20" x 20"	\$430	E2607
Spectrum® Gel Cushion <i>Positioning</i>		
<input type="checkbox"/> 12" x 10" - 20" x 19"	\$480	E2605
<input type="checkbox"/> 20" x 20"	\$530	E2605
Spectrum® Visco Cushion <i>Skin Protection & Positioning</i>		
<input type="checkbox"/> 10" x 10" - 20" x 18"	\$480	E2607
<input type="checkbox"/> 20" x 20"	\$530	E2607
Spectrum® Air <i>Adjustable Skin Protection</i>		
<input type="checkbox"/> 14" x 12" - 20" x 20"	\$480	E2622
Spectrum® Air Contour <i>Adjustable Skin Protection & Positioning</i>		
<input type="checkbox"/> 14" x 12" - 20" x 20"	\$499	E2624
TRU-Comfort™ Seat Cushion <i>General Use</i>		
<i>Includes Allure leather-like cover</i>		
<input type="checkbox"/> 16" x 16" - 20" x 20"	\$380	E2601
TRU-Comfort™ Plus Seat Cushion <i>Skin Protection</i>		
<i>Includes 4-way stretch material cover</i>		
<input type="checkbox"/> 16" x 16" - 20" x 20"	\$380	E2603

LATERALS

Description	Price	HCPCS Code
<input type="checkbox"/> Stealth Thoracic Laterals (pair)¹*		
<i>Bracket:</i>		
<input type="checkbox"/> 125° Swing-Away Bracket	\$450	E1028
<i>For Use on TRU-Comfort Backs w/ Recline</i>		
<input type="checkbox"/> Swing-Away Rail Mounted	\$450	E1028
<i>For Use on Synergy Back and Tru-Comfort (Synergy and Tilt Only)</i>		
<i>Pad:</i>		
<input type="checkbox"/> Flat Pad, 3"x5", Leather-Like Cover	\$200	E0956
<input type="checkbox"/> Flat Pad, 4"x6", Leather-Like Cover	\$200	E0956
<input type="checkbox"/> Curved Pad, 2"x3", 4-Way Stretch Cover	\$200	E0956
<input type="checkbox"/> Curved Pad, 3"x5", 4-Way Stretch Cover	\$200	E0956
<input type="checkbox"/> Curved Pad, 4"x6", 4-Way Stretch Cover	\$200	E0956
<input type="checkbox"/> Stealth Pelvic/Thigh Laterals*		
<i>Side:</i>		
<input type="checkbox"/> Left Side <input type="checkbox"/> Right Side		
<i>Bracket:</i>		
<input type="checkbox"/> Removable Bracket (ea.)	\$250	E1028
<input type="checkbox"/> Removable Bracket w/ 1" Offset (ea.)	\$325	E1028
<input type="checkbox"/> Flip Down Bracket (ea.)	\$225	E1028
<i>Pad:</i>		
<input type="checkbox"/> Short Pad, 4"x4" (ea.)	\$50	E0956
<input type="checkbox"/> Medium Pad, 4"x8" (ea.)	\$50	E0956
<input type="checkbox"/> Long Pad, 4"x12" (ea.)	\$50	E0956
<i>Adapter:</i>		
<input type="checkbox"/> 2" Depth/Height Adapter Plate (ea.) ²	\$25	K0108

1. Swing-away Laterals Interfere with flip-up armrests.
2. Height adapter plate is needed w/ Tru Comfort seat cushion.

Items marked with a (*) should be chosen in the Positioning Components screen in iQuantum

MISCELLANEOUS POSITIONING COMPONENTS

Description	Price	HCPCS Code
<input type="checkbox"/> Therafin Flip-down Knee Abductor Bracket*	\$172	E1028
<i>Pad:</i>		
<input type="checkbox"/> Small <input type="checkbox"/> Medium <input type="checkbox"/> Large	\$135	E0957
<input type="checkbox"/> Stealth Foot Boxes (pair)*	\$475	K0108
<input type="checkbox"/> Small <input type="checkbox"/> Medium <input type="checkbox"/> Large		
<input type="checkbox"/> Stealth Padded Shoe Holders (pair)*	\$166	K0108
<input type="checkbox"/> Small <input type="checkbox"/> Medium <input type="checkbox"/> X-Large		
<input type="checkbox"/> Otto Bock Arm Channels (ea.)*	\$104	E2209
<i>Side:</i>		
<input type="checkbox"/> Left <input type="checkbox"/> Right		
<i>Size:</i>		
<input type="checkbox"/> Small <input type="checkbox"/> Medium <input type="checkbox"/> Large		
<input type="checkbox"/> Otto Bock Flat Hand Pad(ea.)*	\$52	
<i>Side:</i>		
<input type="checkbox"/> Left <input type="checkbox"/> Right		
<i>Size:</i>		
<input type="checkbox"/> Medium <input type="checkbox"/> Large		

Please see positioning components order form for additional types, sizes and details.

ACCESSORIES

Description	Price	HCPCS Code
<input type="checkbox"/> Quantum Backpack ¹	\$60	
<input type="checkbox"/> Oxygen Holder ²	\$150	E2208
<input type="checkbox"/> Recline Accessory Mounting Bracket ³	\$50	
<input type="checkbox"/> Weather Cover, Medium, Black	\$158	
<input type="checkbox"/> Cup Holder	No Charge	
<input type="checkbox"/> Left <input type="checkbox"/> Right		
<input type="checkbox"/> Tablet Holder	\$315	
<input type="checkbox"/> Deluxe Cell Phone/Media Holder	\$140	
<input type="checkbox"/> Cell Phone/Media Holder	No Charge	

1. Backpack may interfere w/ other rear accessories.
2. Oxygen holder on Tilt with Tru Comfort back requires SOF. N/A on Power Recline.
3. 1" adaptor tube allows cane mounted accessories to mount to power recline back or siderail.

LAP BELTS

Description	Price
<input type="checkbox"/> 38" Lap Belt	Standard
<input type="checkbox"/> 50" Lap Belt	Standard
<input type="checkbox"/> 60" Lap Belt	Standard
<input type="checkbox"/> 70" Lap Belt	Standard
<input type="checkbox"/> 80" Lap Belt	Standard
<input type="checkbox"/> 90" Lap Belt	Standard
<input type="checkbox"/> Pelvic Positioning Belt, 2-Point Padded, Medium, 9"-15" Hip Width*	\$87
<input type="checkbox"/> Pelvic Positioning Belt, 2-Point Padded, Large, 13"-19" Hip Width*	\$92
<input type="checkbox"/> Pelvic Positioning Belt, 4-Point Padded, Medium, 9"-15" Hip Width*	\$112
<input type="checkbox"/> Pelvic Positioning Belt, 4-Point Padded, Large, 13-19" Hip Width*	\$116

BATTERY OPTIONS

Description	Price	HCPCS Code
<input type="checkbox"/> NF-22, 50-Amp Batteries		
<input type="checkbox"/> Maintenance Free AGM	\$255 ea.	E2361
<input type="checkbox"/> Maintenance Free Gel Cell (Universal)	\$295 ea.	E2361
<input type="checkbox"/> Maintenance Free Gel Cell (MK)	\$295 ea.	E2361
<i>Installation:</i>		
<input type="checkbox"/> Batteries Installed <input type="checkbox"/> Do Not Install		

Options with a circular checkbox (☐) are NOT available through Quantum West.

COMPACT VENT TRAY

Description	Price
<input type="radio"/> Compact Vent Tray <i>The addition of a compact vent tray may increase the length & weight of your power chair.</i> Mounting Bracket: <input type="radio"/> Flush <input type="radio"/> 3" Offset ¹ <input type="radio"/> 6" Offset <i>Bracket is pre-selected with TRU-Comfort Back</i> <input type="radio"/> Flush <input type="radio"/> 3" Offset ¹ <input type="radio"/> 6" Offset - Accomodates Pulmonetics LTV-style ventilators. - Max Vent Dim. 3.25" H x 10.5" W x 13.5" / 20 lbs. - Not Available with Shape Back or Sling Back. - Not available with rear mount accessories. - Not available on Synergy manual recline, Synergy manual tilt or with flip-down back canes.	\$1,395

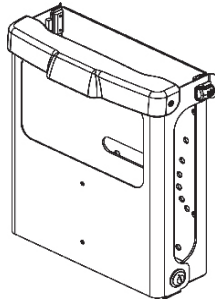

1. Not available with Cane Mounted Flip-up Arms.

ARTICULATING VENT TRAY

Description	Price	HCPCS Code
<input type="radio"/> Articulating Vent Tray ¹ - 14.5"W x 10.5-15.5"D	\$1,450	E1030
<input type="radio"/> Articulating Bi-PAP Vent Tray ¹ - 9.5"W x 9.5-13.5"D	\$1,450	E1030

The addition of an articulating vent or Bi-PAP tray may increase the length & weight of your power chair.

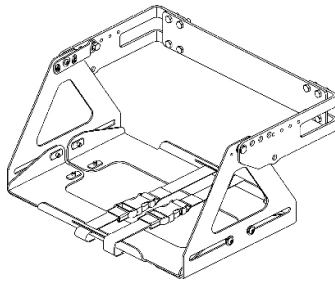

Battery Tray Selection:

<input type="radio"/> Battery Tray	\$450	K0108
<input type="radio"/> Include U1 Battery Box	\$50	K0108
<input type="radio"/> Include U1 Battery	\$133	E2365

1. Not available with TRU Balance Lift, Manual Recline or with rear mounted accessories.

TRANSIT KIT INFO

Q600

THIS SECTION MUST BE READ

The Transit Securement Package, when used in conjunction with a **wheelchair in the specific configuration of a 18"x20" seat size, with 25" high back canes, Full-length height-adjustable single post armrests, Synergy back 25"h, and style 8 swing away legrests and extruded footplates and heel-loops**, conforms with the standard of ANSI/RESNA WC/Vol. 4, Section 19, for the purpose of enabling wheelchairs to be secured in certain types of motor vehicles. The Transit Securement Package, including manufacturer-installed front and rear securement brackets and pelvic belt anchoring brackets, has been crash tested in accordance with ANSI/RESNA WC/Vol. 4, Section 19, Frontal Impact Test, with a 168-lbs. (76.2 kg) surrogate occupant corresponding to a user weight range of 115 lbs. (52.16 kg) to 210 lbs. (95.25 kg). While the Transit Securement Package is compatible with additional seat sizes, optional components, and varied configurations, and provides designated securement points, Pride Mobility makes no claims that any other components or configurations have been tested beyond the above described ANSI/RESNA conforming configuration. Please refer to the Transit Securement Package supplement (**part number INFMANU3658**) for additional information.

RULES:

-All options are available when unoccupied.

Notes when selecting occupied transit kit:

-It is recommended that usable back height be 2" lower than shoulder height.

-Available on Synergy Seat up to 20W x 20D

-Power AFP, ALRs & ELRs are available on Synergy Seating

-All legrests must have heel loops

-Synergy manual seating is N/A

-TRU-Balance Power Positioning seating, options and accessories are N/A

-TRU-Comfort seat cushion is N/A

-Contoured seating is N/A

-Specialty seating is N/A

-Vent option is N/A

-Omit Back option is N/A