

Quantum® Q600

Group 3 Standard
Order Form
300 lbs. weight capacity



Quantum Rehab®

A Division of Pride Mobility Products Corporation®
182 Susquehanna Ave., Exeter, PA 18643
Phone: (866)800-2002 • Fax: (866) 707-3422

Account Number: _____

Provider Name: _____

Contact: _____

Phone: _____

Fax: _____

Date: _____

PO#: _____

Marked For: _____

Ship To: _____

Address: _____

City: _____ State: _____ Zip: _____

Discount: _____

Terms: _____

Freight: _____

Taken By: _____

SET-TO-SPEC*

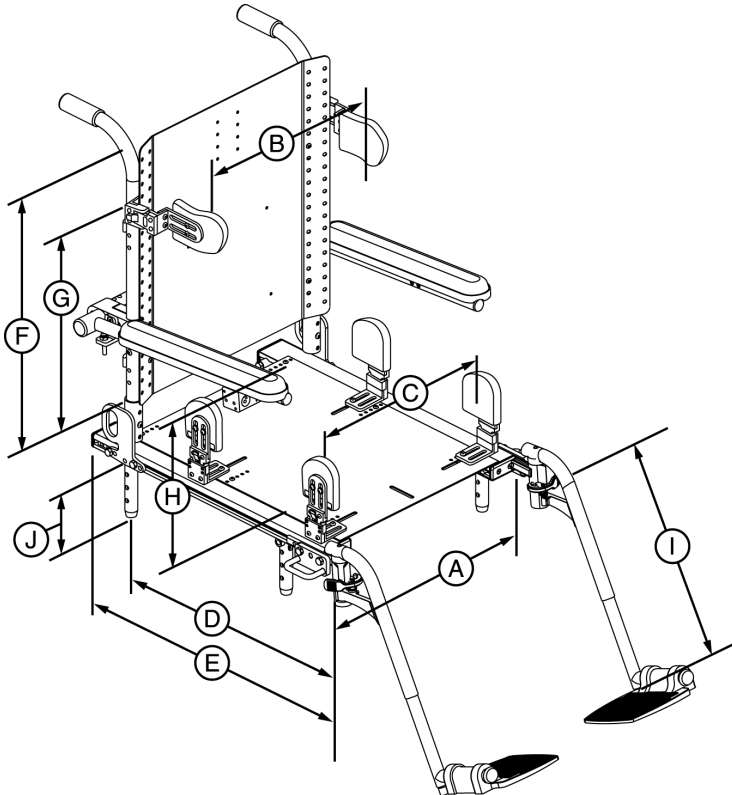

Please Supply Client Information:

Client Height: _____

Client Weight: _____

A. Seat Width: _____

B. Lateral Offset: _____

C. Hip/Thigh Lateral Offset: _____

D. Center of Gravity: Optimized based on seat dimensions

E. Seat Depth: _____

F. Back Height from Pan: _____

G. Lateral Height from Pan: _____

H. Armrest Height from Pan: _____

I. Rigging Length (whole numbers only): _____

J. Seat to Floor Height (circle one): _____

Seating System	Seat-To-Floor Height			
	21"	22"	23"	24"
Contoured Seat	21"	22"	23"	24"
Specialty Seat	17"	18"	19"	20"
Synergy Seat (Standard Stem Mounts)	17"	18"	19"	
Synergy Seat (Extended Stem Mounts)	19"	20"	21"	

*Seat to floor height are +/- 1/8" with 18"W x 18"D with Flat-Free tires (add 3/8" for pneumatic tires).
Increased widths may increase lowest seat to floor heights.*

* While every effort will be taken to ensure dimensions will be preset to your specifications prior to shipping variations in options may effect final settings.

Notes:

DME providers are responsible for determining appropriate billing codes when submitting for insurance reimbursement. HCPCS codes should not be considered as legal advice. All prices are MSRP. Options with a circular checkbox (○) are NOT available through Quantum West.

BASE MODEL

Description	Price	HCPCS Code
<input type="radio"/> Quantum 600 3S-C	\$6,121	K0849
<input type="checkbox"/> Quantum 600 3S-SS	\$6,121	K0848
<input type="radio"/> Quantum 600 3SP-C <i>An SP-C describes a base with an alternative drive device with a captain's seat</i>	\$6,321	K0857

COLORS

- Metallic Colors:**
- Candy Apple Red
 - Viper Blue
 - Onyx Black
 - Sunburst Orange
 - Pearl Pink
 - Silver
 - Emerald Green
 - Sapphire Blue

MOTOR OPTIONS

Description	Price	HCPCS Code
<input type="checkbox"/> Standard Motor Package	Standard	
<input type="radio"/> High Speed Motor Package	\$1,574	
<i>Programmable Speed Up To 6 MPH, 300 lbs. Wt. Capacity. HS Motors decrease per-charge range.</i>		
<input type="radio"/> Accu-Trac Motor Technology <i>Delivers Enhanced Traction and Tracking Especially With Switched Drive Controls Requires Q-Logic EX.</i>	\$1,295	K0108
<input type="radio"/> Community Use Package ¹ <u>Package Includes:</u> - 300 lbs. Weight Capacity - 4-Pole High Speed Motor Package - 4" Wide Flat Free, Knobby, Extended Traction Tires	\$2,125	

1. Increases overall base width by 1.5".

BASE MOUNTED FOOT PLATFORM

Description	Price
<input type="checkbox"/> Base Mounted Foot Platform Installed	Standard
<input type="checkbox"/> No Base Mounted Foot Platform	No Charge

DRIVE WHEELS

Description	Price
<input type="checkbox"/> 14" Flat-Free	Standard
<input type="checkbox"/> 14" Pneumatic	No Charge
<input type="radio"/> 4" Wide Flat Free, Knobby, Extended-Traction Tires ¹	\$551
<input type="radio"/> 4" Wide Pneumatic, Knobby, Extended-Traction Tires ¹	\$551

1. Increases overall base width by 1.5" with Flat Free.

BATTERY CHARGER

Description	Price	HCPCS Code
<input type="checkbox"/> 5 Amp Off-board Charger	Standard	

TRANSIT KIT

Description	Price
<i>Refer to last page for Details Regarding Occupied and Unoccupied Transit Kits</i>	
<input type="radio"/> Occupied Transit Kit	\$350
<input type="checkbox"/> Unoccupied Transit Kit ¹	No Charge

1. Unoccupied Transit Kit with a Vent Tray may not allow lowest seat to floor height, vent tray unavailable w/ Occupied Transit Kit.

LED LIGHT PACKAGE

Description	Price
<input type="radio"/> Through Q-Logic EX w/ Lights	\$995

NON-EXPANDABLE CONTROLS

Description	Price
<input type="checkbox"/> 75 Amp NE	Standard
<input type="checkbox"/> 75 Amp NE+ 6-Key For Up To 2 Actuators Thru Joystick	\$200 <i>Standard on 3SP-C Package</i>

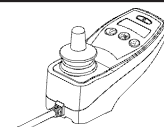

EXPANDABLE CONTROLS

Description	Price	HCPCS Code
-------------	-------	------------

Q-Logic EX Joystick or Enhanced Display must be ordered with a Q-Logic EX Controller and Harness For Expandable Controls

<input type="checkbox"/> 100 Amp Q-Logic EX Controller	\$695	E2377
<input type="checkbox"/> Expandable Controller Harness	\$350	E2313

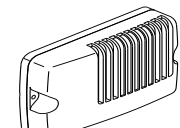

<input type="checkbox"/> Q-Logic EX Joystick	\$700	
----------------------------------------------	-------	--

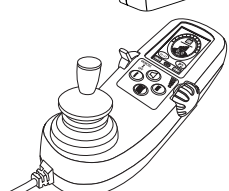

<input type="radio"/> Q-Logic EX Joystick w/ Lighting	\$700	
-------------------------------------------------------	-------	--

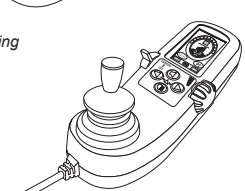

PROGRAMMING

Description	Price
-------------	-------

<input type="checkbox"/> Q-Logic Handheld Programmer	\$545
------------------------------------------------------	-------



<input type="checkbox"/> Q-Logic PC Programming Cable with Disk ¹	\$750
------------------------------------------------------------------------------	-------

1. Works with Q-Logic EX only.

JOYSTICK HANDLES

Description	Price	HCPCS Code
-------------	-------	------------

<input type="checkbox"/> Standard Carrot Handle	Standard	
<input type="checkbox"/> Mushroom Handle	\$71	E2323
<input type="checkbox"/> T-Bar	\$107	E2323
<input type="checkbox"/> Chin Cup	\$71	E2324 ¹
<input type="checkbox"/> Extended I-Handle	\$71	E2323
<input type="checkbox"/> Soft Ball Handle	\$50	E2323
<input type="checkbox"/> Medium Ball Handle	\$50	E2323
<input type="checkbox"/> Bodypoint 3" Goal Post Handle	\$69	E2323
<input type="checkbox"/> Bodypoint 4" Goal Post Handle	\$69	E2323

1. Use HCPCS code E2323 when not used in conjunction with a chin control.

Options with a circular checkbox (○) are NOT available through Quantum West.

JOYSTICK MOUNTING BRACKETS		
Description	Price	HCPCS Code
<i>Comes Standard with a Quick Release, Adjustable-Height Joystick Block</i>		
<input type="checkbox"/> Fixed Inline ¹	Standard	
Side: <input type="checkbox"/> Left <input type="checkbox"/> Right		
<input type="checkbox"/> Swing-away	\$210	E1028
Side: <input type="checkbox"/> Left <input type="checkbox"/> Right		
Style: <input type="checkbox"/> Inline <input type="checkbox"/> Offset		
Length: <input type="checkbox"/> 4" Ext. <input type="checkbox"/> 7" Ext. ²		
<input type="checkbox"/> Multi-axis Fixed	\$100	K0108
Side: <input type="checkbox"/> Left <input type="checkbox"/> Right		

1. Not available with Q-Logic EX Stand Alone Joystick
2. In iQuantum choose in addition to Swing-Away 4" mount.

CONTOURED SEATING		
Description	Price	HCPCS Code
High Back:		
<input type="checkbox"/> Limited Recline High-Back with Headrest	No Charge	
<input type="checkbox"/> Limited Recline High-Back with Headrest & Solid Seat Pan ¹	No Charge	
Seat Width:		
<input type="checkbox"/> 18" <input type="checkbox"/> 20"		
Seat Depth:		
<input type="checkbox"/> 18" <input type="checkbox"/> 20"		
Upholstery:		
<input type="checkbox"/> Black Vinyl		
Depth Adjustable High Back:		
<input type="checkbox"/> Limited Recline Depth Adjustable High Back w/ Headrest ¹	No Charge	
Color: <input type="checkbox"/> Gray Vinyl <input type="checkbox"/> Black Vinyl		
Size: <input type="checkbox"/> 18"W x 18-20"D <input type="checkbox"/> 20"W x 18-20"D		

Armrests:		
<input type="checkbox"/> Flip-Up, Removable	No Charge	
<input type="checkbox"/> Flip-Up, Height-Adjustable, Removable	\$85 ea.	E0973
Armrests:		
Left: <input type="checkbox"/> Full Length <input type="checkbox"/> Desk Length		
Right: <input type="checkbox"/> Full Length <input type="checkbox"/> Desk Length		

Special Order Seat

_____ "W x _____ "D

Seat size can not exceed 22"W x 20"D

\$450 MSRP

1. Seat comes automatically with a 60" belt. Requires Full Length Arms.

MANUAL RECLINER		
Description	Price	HCPCS Code
<input type="checkbox"/> Manual Recliner High Back with Headrest	\$600	E1226
<input type="checkbox"/> Manual Recliner High Back with Headrest and Solid Seat Pan ¹	\$600	E1226
Upholstery:		
<input type="checkbox"/> Black Vinyl		
Seat Width:		
<input type="checkbox"/> 16" <input type="checkbox"/> 18" <input type="checkbox"/> 20"		
Seat Depth:		
<input type="checkbox"/> 16" <input type="checkbox"/> 18" <input type="checkbox"/> 20"		
Armrests:		
Left: <input type="checkbox"/> Full Length <input type="checkbox"/> Desk Length		
Right: <input type="checkbox"/> Full Length <input type="checkbox"/> Desk Length		

1. Includes black vinyl seatpan. Back available in listed colors.

SPECIALTY SEATING		
Description	Price	HCPCS Code
<input type="checkbox"/> Specialty Seating Kit	No Charge	
Seat Width:		
<input type="checkbox"/> 16" <input type="checkbox"/> 18" <input type="checkbox"/> 20"		
Seat Depth:		
<input type="checkbox"/> 16" <input type="checkbox"/> 17" <input type="checkbox"/> 18" <input type="checkbox"/> 19" <input type="checkbox"/> 20"		
Back Cane Height:		
<input type="checkbox"/> 18" <input type="checkbox"/> 20" <input type="checkbox"/> 22"		
Back Rest Height:		
<input type="checkbox"/> 18" <input type="checkbox"/> 20" <input type="checkbox"/> 22"		
Armrests:		
<input type="checkbox"/> 2-Post, Fixed, Flip Back ¹	No Charge	
<input type="checkbox"/> Flip-Back, Cane Mounted ¹	\$95 ea.	
<input type="checkbox"/> Removable, Adjustable, Quick Height ²	\$275 ea.	E0973
<input type="checkbox"/> Removable, Single-Post, Fixed Height Adjustable Heavy Duty	\$150 ea.	E0973
<input type="checkbox"/> 8-12" Adjustment <input type="checkbox"/> 10-14" Adjustment		
<input type="checkbox"/> Pediatric, Removable ³	\$275	E0973
Color: <input type="checkbox"/> Match Shroud <input type="checkbox"/> Black		
<input type="checkbox"/> Quad Release Lever		
Armpads:		
Left: <input type="checkbox"/> Full Length <input type="checkbox"/> Desk Length		
Right: <input type="checkbox"/> Full Length <input type="checkbox"/> Desk Length		

1. Swing-away Laterals Interfere with flip-back arms. Call for configuration with Shape back.
2. Adjustable from 11" to 17"H in 1/2" increments.
3. Height adjustable from 7.75"-9.75" in 1/2" increments. Full length armpads not available.

SYNERGY® SEATING SYSTEMS		
Description	Price	HCPCS Code
<input type="checkbox"/> Synergy Seating Frame	\$434	
<input type="checkbox"/> Standard Stem Mounts		
<input type="checkbox"/> 2" Extended Vertical Stem Mounts ¹		
<input type="checkbox"/> Synergy Manual Recline Package ²	\$700	E1226
<input type="checkbox"/> Synergy Manual Tilt Package ³	\$550	K0108
<i>Max. Seat Size 14"W x 14"D, 75 lbs Weight Capacity</i>		
Seat Width:		
<input type="checkbox"/> 10" <input type="checkbox"/> 11" <input type="checkbox"/> 12" <input type="checkbox"/> 13" <input type="checkbox"/> 14"		
<input type="checkbox"/> 15" <input type="checkbox"/> 16" <input type="checkbox"/> 17" <input type="checkbox"/> 18" <input type="checkbox"/> 19"		
<input type="checkbox"/> 20"		
Seat Width Package:		
<input type="checkbox"/> 10"W-14"W <input type="checkbox"/> 14"W-18"W <input type="checkbox"/> 16"W-20"W		
Seat Depth:		
<input type="checkbox"/> 10" <input type="checkbox"/> 11" <input type="checkbox"/> 12" <input type="checkbox"/> 13" <input type="checkbox"/> 14"		
<input type="checkbox"/> 15" <input type="checkbox"/> 16" <input type="checkbox"/> 17" <input type="checkbox"/> 18" <input type="checkbox"/> 19"		
<input type="checkbox"/> 20"		
Seat Depth Package:		
<input type="checkbox"/> 10"D-14"D <input type="checkbox"/> 14"D-18"D <input type="checkbox"/> 15"D-20"D		
Back Cane Height:		
<input type="checkbox"/> 14" <input type="checkbox"/> 15" <input type="checkbox"/> 16" <input type="checkbox"/> 17"		
<input type="checkbox"/> 18" <input type="checkbox"/> 19" <input type="checkbox"/> 20" <input type="checkbox"/> 21"		
<input type="checkbox"/> 22" <input type="checkbox"/> 23" <input type="checkbox"/> 24" <input type="checkbox"/> 25"		

1. Increases seat to floor height by 2". Lowest seat-to-floor height not available.
2. Not available with Flip Back Arms, Cantilever Arms or Shape Back. Requires 22"H canes. Pivot point 2.5" above seat pan.
3. In i-Quantum this option is chosen under "Width Package Type"

SYNERGY® BACK OPTIONS		
Description	Price	HCPCS Code
<input type="checkbox"/> Synergy® Shape Back <i>Positioning Back</i>	Various	E2613/E2614
<i>See Synergy Shape Back Order Form For Detailed Pricing, Sizes and Codes</i>		
<input type="checkbox"/> Sling Back	\$98	
<input type="checkbox"/> Omit Back	No Charge	
<input type="checkbox"/> Synergy® Back with 1.5" Thick Back Cushion	\$275	
Overall Back <input type="checkbox"/> 18" H <input type="checkbox"/> 19" H <input type="checkbox"/> 20" H <input type="checkbox"/> 21" H		
Height: <input type="checkbox"/> 22" H <input type="checkbox"/> 23" H <input type="checkbox"/> 24" H <input type="checkbox"/> 25" H		
<i>Choose Lateral Extensions:</i>		
<input type="checkbox"/> 6" for 13"-16"H Back	\$25	
<input type="checkbox"/> 10" for 17"-18"H Back	\$25	
<input type="checkbox"/> 12" For 19"-22"H Back	\$25	
<input type="checkbox"/> 16" For 23"-25"H Back	\$25	

Options with a circular checkbox (○) are NOT available through Quantum West.

SYNERGY® BACK OPTIONS (CONT'D)

Description	Price	HCPCS Code
<input type="checkbox"/> TRU-Comfort™ Back¹ 4-way Stretch Material Cover Width: <input type="checkbox"/> 16"W <input type="checkbox"/> 18" W <input type="checkbox"/> 20"W	\$595	E2620
Overall Back Height ² : <input type="checkbox"/> 20" H <input type="checkbox"/> 21" H <input type="checkbox"/> 22"H <input type="checkbox"/> 23"H <input type="checkbox"/> 24"H <input type="checkbox"/> 25"H <input type="checkbox"/> 27"H <input type="checkbox"/> 28"H		
Width: <input type="checkbox"/> 17"W <input type="checkbox"/> 19"W	\$595	E2620
Overall Back Height ¹ : <input type="checkbox"/> 22"H <input type="checkbox"/> 23"H <input type="checkbox"/> 24"H <input type="checkbox"/> 25"H <input type="checkbox"/> 27"H <input type="checkbox"/> 28"H		
Width: <input type="checkbox"/> 22"W ³ <input type="checkbox"/> 24"W ³	\$695	E2621
Overall Back Height ¹ : <input type="checkbox"/> 24"H <input type="checkbox"/> 25"H <input type="checkbox"/> 27"H <input type="checkbox"/> 28"H		

Tru Comfort Color Shroud Option:

Black (Standard color option)

Metallic Colors:\$100

- Candy Apple Red
- Viper Blue
- Sunburst Orange
- Pearl Pink
- Silver
- Emerald Green
- Sapphire Blue

Synergy® Back Cane Options:

- Standard Back Canes Standard \$125
 - Omit Push Handles \$125
- Flip Forward Back Canes⁴ \$150
 - Omit Push Handles \$125
- Offset (Meso)⁵ \$195
 - 2" (1" Per Side) 4" (2" Per Side)
- Inset (Endo) \$195
 - 2" (1" Per Side) 4" (2" Per Side)

1. Not available on Specialty Seating Kit.
 2. Overall Back height measurement is measured from the seat pan to the top of the back, +/- 1/2".
 3. Available with offset (meso) brackets.
 4. Not available with Vent Tray, or O2 Holder. May interfere with Lateral Supports and Waterfall Armpads.
 5. Dual Post Flip-back Armrests interfere with offset canes.

SYNERGY® ARMRESTS

Description	Price	HCPCS Code
<input type="checkbox"/> Flip-back, Cane Mounted ¹	No Charge	
<input type="checkbox"/> 2-post, Flip-back, Height-adjustable, Removable ^{2,3}	\$150 ea.	E0973
<input type="checkbox"/> Single-post, Height-adjustable, Removable ^{3,4} <input type="checkbox"/> Quad Release Lever	\$75 ea.	E0973
<input type="checkbox"/> Removable, Single-post, Height Adjustable, Heavy Duty <input type="checkbox"/> 8"H - 12"H <input type="checkbox"/> 10"H-14"H	\$75 ea.	E0973
<input type="checkbox"/> Pediatric, Removable ⁵ Color: <input type="checkbox"/> Match Shroud <input type="checkbox"/> Black <input type="checkbox"/> Quad Release Lever	\$75 ea.	E0973
<input type="radio"/> Bariatric, Removable, Height Adjustable ⁶ <input type="checkbox"/> 8"H - 12"H <input type="checkbox"/> 10"H-14"H	\$75 ea.	E0973
<input type="checkbox"/> Height Adjustable Cantilever Armrests ⁷ Angle-Adjustable: -30° through +30°	\$195	K0020

1. Interferes with swing-away laterals.
 2. Interferes with swing-away laterals. Height adjustable from 9"-13" in 1" increments.
 3. Not available with a depth less than 14".
 4. Height adjustable from 11"-17" in 1/2" increments
 5. Height adjustable from 7.75"-9.75" in 1/2" increments. Full length armpads not available
 6. Bariatric Armrests require Bariatric Armpads
 7. Height adjustment from 11-17" depends on cane height. Not available with Manual Recline, Flip Forward back canes, Cane Clamp Pushbar, & Shape Back. Call for details when selecting aftermarket arm troughs or Universal Swivel.

SYNERGY® ARMPADS

Description	Price
<input type="checkbox"/> Straight, Full Length (2"x14") <input type="checkbox"/> Left <input type="checkbox"/> Right	Standard
<input type="checkbox"/> Straight, Desk Length (2"x10") <input type="checkbox"/> Left <input type="checkbox"/> Right	No Charge
<input type="checkbox"/> Waterfall, Full Length (2"x14") ¹ <input type="checkbox"/> Left <input type="checkbox"/> Right	No Charge
<input type="checkbox"/> Waterfall, Desk Length (2"x10") ¹ <input type="checkbox"/> Left <input type="checkbox"/> Right	No Charge
<input type="checkbox"/> Falcon Gel, Full Length, (3.5"x14")* <input type="checkbox"/> Left <input type="checkbox"/> Right <input type="checkbox"/> Full Length Gel Armpad Mounting Plate (Required)*	\$160 pr. \$56.69 ea.
<input type="checkbox"/> Falcon Gel, Desk Length, (3.5"x10")* <input type="checkbox"/> Left <input type="checkbox"/> Right <input type="checkbox"/> Desk Length Gel Armpad Mounting Plate (Required)*	\$125 pr. \$53.52 ea.
<input type="radio"/> Flat, Bariatric ² <input type="checkbox"/> Left <input type="checkbox"/> Right	No Charge

1. Not available w/ Cane Mounted, Flip Back Armrests combined with a Synergy Back.
 2. Bariatric Armrests require Bariatric Armpads

HEADRESTS

Description	Price	HCPCS Code
<input type="checkbox"/> No Headrest Required		
<input type="checkbox"/> TRU-Comfort™ Headrest¹:		
<input type="checkbox"/> 8" W Leatherette	\$205	E0955
<input type="checkbox"/> 8"W TRU-Comfort Plus	\$205	E0955
<input type="checkbox"/> 10" W Leatherette	\$205	E0955
<input type="checkbox"/> 10"W TRU-Comfort Plus	\$205	E0955
<input type="checkbox"/> Removable Headrest Bracket	\$210	E1028
Stealth:		
<input type="checkbox"/> Small (9.75"W x 3"H) (STL-OTSMS250)	\$205	E0955
<input type="checkbox"/> Large (11"W x 6"H) (STL-OTLG150)	\$205	E0955
<input type="checkbox"/> Pediatric Comfort Plus (6"W) (CPN350)	\$142	E0955
<input type="checkbox"/> Small Comfort Plus (10"W) (CP250)	\$142	E0955
<input type="checkbox"/> Large Comfort Plus (14"W) (CP150)	\$142	E0955
<input type="checkbox"/> Removable Headrest Bracket ² (HMO475P)	\$210	E1028
<input type="checkbox"/> Swing-away (Flip-down) Headrest Bracket (FDM350) Used in Addition to Removable Headrest Bracket	\$210	
Aftermarket Bracket:		
<input type="checkbox"/> Stealth's World's Best Removable Headrest Hardware (TWB485)	\$210	E1028

1. Measurement is taken from the inside of the headrest.

NON-POWERED LEGRESTS

Description	Price	HCPCS Code
<input type="checkbox"/> 70° Swing-away Legrests¹	\$162	
<input type="checkbox"/> Straight <input type="checkbox"/> Tapered		
<input type="checkbox"/> Standard Extruded Footplates Standard Extruded Extensions: <input type="checkbox"/> 11"-13" <input type="checkbox"/> 13"-16.5" <input type="checkbox"/> 15.5"-19.5"	No Charge	
Standard Extruded Footplates: <input type="checkbox"/> 7.25" x 6" <input type="checkbox"/> 8.5" x 6"		
<input type="checkbox"/> Angle-Adjustable Footplates ²	\$150	K0040
Angle Adjustable Extensions: <input type="checkbox"/> 11"-13" <input type="checkbox"/> 13"-16.5" <input type="checkbox"/> 15.5"-19.5"		
Angle-Adjustable Footplates: <input type="checkbox"/> 4" x 6" <input type="checkbox"/> 5" x 6" <input type="checkbox"/> 5" x 8" <input type="checkbox"/> 6" x 8" ³ <input type="checkbox"/> 6" x 11" ³ <input type="checkbox"/> 8" x 11" ⁴		
<input type="checkbox"/> Multi-Axis Footplates	\$495	K0040
Multi-Axis Extensions: <input type="checkbox"/> 11"-16.5" <input type="checkbox"/> 15.5"-19.5"		
Multi-Axis Footplates: <input type="checkbox"/> 4" x 6" <input type="checkbox"/> 5" x 6" <input type="checkbox"/> 5" x 8" <input type="checkbox"/> 6" x 8" ³ <input type="checkbox"/> 6" x 11" ³ <input type="checkbox"/> 8" x 11" ⁴		

1. Legrest Extensions are measured from seatpan to footplate.
 2. Includes Heel Loops
 3. Causes interference on seat widths less than 18".
 4. Causes interference on seat widths less than 20".

Items marked with a (*) should be chosen in the Positioning Components screen in iQuantum

Options with a circular checkbox (☐) are NOT available through Quantum West.

NON-POWERED LEGRESTS

Description	Price	HCPCS Code
<input type="checkbox"/> High Mount, Clamp-On Footrest*		
<input type="checkbox"/> Angle Adjustable		K0040
<input type="checkbox"/> Small, 4" x 7.75"	\$356	
<input type="checkbox"/> Large, 4.25" x 9.25"	\$356	
<input type="checkbox"/> Multi-Axis		K0040
<input type="checkbox"/> Small, 4" x 7.75"	\$456	
<input type="checkbox"/> Large, 4.25" x 9.25"	\$460	
<input type="checkbox"/> Heavy Duty Drop-In Legrests¹	\$420	
<input type="checkbox"/> Angle Adjustable Footplates ²	\$150	K0040
Angle Adjustable Extension Length:		
<input type="checkbox"/> 12"-14.5"		<input type="checkbox"/> 14.5" -18"
Angle Adjustable Footplate Size:		
<input type="checkbox"/> 4" x 6"		<input type="checkbox"/> 5" x 6"
<input type="checkbox"/> 6" x 8" ³		<input type="checkbox"/> 6" x 11" ³
<input type="checkbox"/> 5" x 8"		<input type="checkbox"/> 8" x 11" ⁴
<input type="checkbox"/> Elevating Legrests	\$325	K0195/E0990 ⁵
<input type="checkbox"/> Standard Footplates		
Standard Extruded Extension Length:		
<input type="checkbox"/> 11"-14"		<input type="checkbox"/> 14"-17"
Standard Extruded Footplate Size:		
<input type="checkbox"/> 7.25" x 6"		<input type="checkbox"/> 8.5" x 6"
<input type="checkbox"/> Angle Adjustable Footplates ²	\$150	K0040
Angle Adjustable Extension Length:		
<input type="checkbox"/> 12"-14.5"		<input type="checkbox"/> 14.5" -18"
Angle Adjustable Footplate Size:		
<input type="checkbox"/> 4" x 6"		<input type="checkbox"/> 5" x 6"
<input type="checkbox"/> 6" x 8" ³		<input type="checkbox"/> 6" x 11" ³
<input type="checkbox"/> 5" x 8"		<input type="checkbox"/> 8" x 11" ⁴
<input type="checkbox"/> Calf Pad Adjustment		
<input type="checkbox"/> 1 Hole		<input type="checkbox"/> 3 Hole
<input type="checkbox"/> 6 Hole		
<input type="checkbox"/> 90° Pediatric Swing-Away Legrests¹	\$162	
<input type="checkbox"/> Angle Adjustable Footplate ²		
Angle Adjustable Extension Length:		
<input type="checkbox"/> 7"-10"		
Angle Adjustable Footplate Size:		
<input type="checkbox"/> 4" x 6"		<input type="checkbox"/> 5" x 6"

1. Legrest Extensions are measured from seatpan to footplate.
2. Includes heel loops.
3. Causes interference on seat widths less than 18"
4. Causes interference on seat widths less than 20"
5. E0990 code used for purchase in CBA. K0195 code used for capped rental.

New!!!

ADJUSTABLE CENTER MOUNT FOOT PLATFORM

Description	Price
<input type="checkbox"/> Adjustable Center Mount Foot Platform ¹	\$250
Includes 10"W x 11"D Split Foot Platform	
Extensions: ²	
<input type="checkbox"/> 8"-12" Ext.	
<input type="checkbox"/> 10"-14" Ext.	
<input type="checkbox"/> 10"-16" Ext.	
<input type="checkbox"/> 13"-19" Ext.	
Calf Supports ³ :	
<input type="checkbox"/> Calf Pads (pair)	\$150
<input type="checkbox"/> Small (6"H x 6"W)	
<input type="checkbox"/> Large (8"H x 8"W, Tapered to 6"W) ⁴	
Optional Modular Footplate Extension Components/Kits ^{3,5}	
<input type="checkbox"/> 4" Width Extension Kit	\$50
<input type="checkbox"/> 2" Bell Shaped, Length Extension Kit	\$50

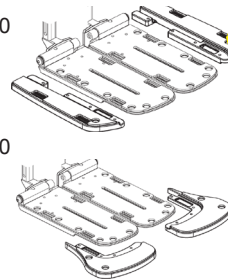

1. Only available on Synergy Seating Systems.
2. Extension length is measured from top of the seat pan to footplate.
3. Choose in Rigging Accessory Section in iQuantum.
4. Not available with 8-12" or 10-14" extensions.
5. Assembly required. May require seating configuration adjustments to avoid front caster interference.

ADJUSTABLE CENTER MOUNT FOOT PLATFORM (CONT'D)

Description	Price
<input type="checkbox"/> 4" Width Extension with 2" Bell Shaped, Length Extension Kit	\$75
<input type="checkbox"/> 6-Piece Extension Stock Kit	\$95
(Includes all above pieces)	
Additional Optional Accessories ⁶ :	
<input type="checkbox"/> Footplate Connector	\$49

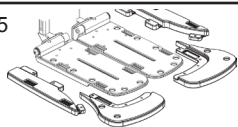

6. Choose in Rigging Accessory Section in iQuantum.

ELECTRONICS FOR POWER LEGRESTS

Description	Price	HCPCS Code
<input type="checkbox"/> Single Actuator Through Joystick	\$1,175	E2310 ¹
(AFP Only or PES Only)		
<input type="checkbox"/> Dual Actuator Through NE+ 6-Key	\$2,375	E2311 ²
(Power Legrests or AFP with PES)		
<input type="checkbox"/> Multiple Actuator Through Q-Logic EX	\$2,375	E2311 ²

1. HCPCS used only with Power AFP.
2. HCPCS used only with Power Legrests

POWER ELEVATING LEGRESTS

Description	Price	HCPCS Code
<input type="checkbox"/> 70° Articulating Swing-Away Legrests, 4" Articulation Range¹	\$2,395	E1010
<input type="checkbox"/> Quad Release Lever		
Calf Pads ² :		
<input type="checkbox"/> 6" x 5.35"		<input type="checkbox"/> 8" x 5.86"
Angle Adjustable Extension Length ³ :		
<input type="checkbox"/> 11"-13"		<input type="checkbox"/> 14.5"-18"
Angle Adjustable Footplate Size:		
<input type="checkbox"/> 4" x 6"		<input type="checkbox"/> 5" x 6"
<input type="checkbox"/> 5" x 8"		<input type="checkbox"/> 6" x 8" ⁴
<input type="checkbox"/> 6" x 11" ⁴		<input type="checkbox"/> 8" x 11" ⁵
Operational Method:		
<input type="checkbox"/> Independent		<input type="checkbox"/> Combined
<input type="checkbox"/> 70° Articulating Drop-In Legrests¹	\$2,395	E1010
<input type="checkbox"/> 4" Range		<input type="checkbox"/> 6" Range
Calf Pads ² :		
<input type="checkbox"/> 6" x 5.35"		<input type="checkbox"/> 8" x 5.86"
Angle Adjustable Extension Length ³ :		
<input type="checkbox"/> 12"-14.5"		<input type="checkbox"/> 14.5"-18"
Angle Adjustable Footplate Size:		
<input type="checkbox"/> 4" x 6"		<input type="checkbox"/> 5" x 6"
<input type="checkbox"/> 5" x 8"		<input type="checkbox"/> 6" x 8" ⁴
<input type="checkbox"/> 6" x 11" ⁴		<input type="checkbox"/> 8" x 11" ⁵
Operational Method:		
<input type="checkbox"/> Independent		<input type="checkbox"/> Combined

1. Only available on Synergy Seating Systems.
2. Choose in Rigging Accessory Section in iQuantum.
3. Extensions are measured from top of seat pan to footplate.
4. Only available with seat width 18" or greater.
5. Only available with seat width 20" or greater.

CENTER MOUNT ARTICULATING FOOT PLATFORM

Description	Price	HCPCS Code
<input type="checkbox"/> Center Mount Articulating Foot Platform ¹	\$2895	K0108
Includes 10"W x 11"D Split Foot Platform		
Extensions ² :		
<input type="checkbox"/> 10"-16" Ext.		<input type="checkbox"/> 13"-19" Ext.
Calf Supports ³ :		
<input type="checkbox"/> Calf Pads (pair)		
<input type="checkbox"/> Small (6"H x 6"W)		
<input type="checkbox"/> Large (8"H x 8"W, Tapered to 6"W)		

1. Only available on Synergy Seating Systems.
2. Extensions measured from top of seatpan to footplate.
3. Choose in Rigging Accessory Section in iQuantum.

Items marked with a (*) should be chosen in the Positioning Components screen in iQuantum

Options with a circular checkbox (○) are NOT available through Quantum West.

CENTER MOUNT ARTICULATING FOOT PLATFORM (CONT'D)

LATERALS

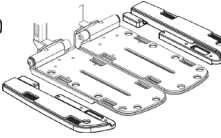
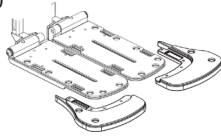
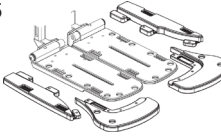
Description	Price	
Optional Modular Footplate Extension Components/Kits ^{1,2}		
<input type="checkbox"/> 4" Width Extension Kit	\$50	
<input type="checkbox"/> 2" Bell Shaped, Length Extension Kit	\$50	
<input type="checkbox"/> 4" Width Extension with 2" Bell Shaped, Length Extension Kit	\$75	
<input type="checkbox"/> 6-Piece Extension Stock Kit (Includes all above pieces)	\$95	
Additional Optional Accessories:		
<input type="checkbox"/> Footplate Connector ¹	\$49	

1. Choose in Rigging Accessory Section in iQuantum.
2. Assembly required. May require seating configuration adjustments to avoid front caster interference.

FRONT RIGGING ACCESSORIES

Description	Price	HCPCS Code
<input type="checkbox"/> Wheel Bumpers	\$25	
<input type="checkbox"/> Heel Loops (pair) ¹	\$38	E0951
<input type="checkbox"/> Gel Neoprene Footrest Sleeve (pair) ²	\$65	K0108
<input type="checkbox"/> ELR/ALR Adductor Buttons (pair)	\$125	K0108
<input type="checkbox"/> POSAlinc Knee Adductor for Swing-Away Legrests (pair) [*]	\$256	K0108
<input type="checkbox"/> POSAlinc Rail Mounted Knee Adductor (pair) [*]	\$287	K0108
<input type="checkbox"/> Residual Limb Support	\$300	E1020
<input type="checkbox"/> Left <input type="checkbox"/> Right		
<input type="checkbox"/> Bodypoint Ankle Huggers (pair) [*]	\$134	K0108
<input type="checkbox"/> Small <input type="checkbox"/> Medium		

1. Standard with Angle Adjustable or Multi-Axis footplates.
2. Only available with Swing-Away legrests.

SEAT CUSHIONS

Description	Price	HCPCS Code
<input type="checkbox"/> No Cushion Required		
<i>Please refer to Synergy order forms for detailed pricing, sizes and codes.</i>		
Simplicity Cushion General Use		
<input type="checkbox"/> 16" x 16" - 20" x 20"	\$98	E2601
Solution® 1 Cushion Skin Protection:		
<input type="checkbox"/> 14" x 14" - 20" x 18"	\$380	E2603
<input type="checkbox"/> 20" x 20"	\$430	E2603
Solution® Cushion Skin Protection & Positioning		
<input type="checkbox"/> 10" x 10" - 20" x 18"	\$380	E2607
<input type="checkbox"/> 20" x 20"	\$430	E2607
Spectrum® Gel Cushion Positioning		
<input type="checkbox"/> 12" x 10" - 20" x 19"	\$480	E2605
<input type="checkbox"/> 20" x 20"	\$530	E2605
Spectrum® Visco Cushion Skin Protection & Positioning		
<input type="checkbox"/> 10" x 10" - 20" x 18"	\$480	E2607
<input type="checkbox"/> 20" x 20"	\$530	E2607
Spectrum® Air Adjustable Skin Protection		
<input type="checkbox"/> 14" x 12" - 20" x 20"	\$480	E2622
Spectrum® Air Contour Adjustable Skin Protection & Positioning		
<input type="checkbox"/> 14" x 12" - 20" x 20"	\$499	E2624
TRU-Comfort™ Seat Cushion General Use <i>Includes Allure leather-like cover</i>		
<input type="checkbox"/> 16" x 16" - 20" x 20"	\$380	E2601
TRU-Comfort™ Plus Seat Cushion Skin Protection <i>Includes 4-way stretch material cover</i>		
<input type="checkbox"/> 16" x 16" - 20" x 20"	\$380	E2603

Description	Price	HCPCS Code
<input type="checkbox"/> Stealth Thoracic Laterals (pair)^{1*}		
Bracket:		
<input type="checkbox"/> Swing-Away Rail Mounted	\$450	E1028
<i>For Use on Synergy Back and Tru-Comfort</i>		
Pad:		
<input type="checkbox"/> Flat Pad, 3"x5", Leather-Like Cover	\$200	E0956
<input type="checkbox"/> Flat Pad, 4"x6", Leather-Like Cover	\$200	E0956
<input type="checkbox"/> Curved Pad, 2"x3", 4-Way Stretch Cover	\$200	E0956
<input type="checkbox"/> Curved Pad, 3"x5", 4-Way Stretch Cover	\$200	E0956
<input type="checkbox"/> Curved Pad, 4"x6", 4-Way Stretch Cover	\$200	E0956
<input type="checkbox"/> Stealth Pelvic/Thigh Laterals[*]		
Side:		
<input type="checkbox"/> Left Side <input type="checkbox"/> Right Side		
Bracket:		
<input type="checkbox"/> Removable Bracket (ea.)	\$250	E1028
<input type="checkbox"/> Removable Bracket w/ 1" Offset (ea.)	\$325	E1028
<input type="checkbox"/> Flip Down Bracket (ea.)	\$225	E1028
Pad:		
<input type="checkbox"/> Short Pad, 4"x4" (ea.)	\$50	E0956
<input type="checkbox"/> Medium Pad, 4"x8" (ea.)	\$50	E0956
<input type="checkbox"/> Long Pad, 4"x12" (ea.)	\$50	E0956
Adapter:		
<input type="checkbox"/> 2" Depth/Height Adapter Plate (ea.) ²	\$25	K0108

1. Swing-away Laterals Interfere with flip-up armrests.
2. Height adapter plate is needed w/ Tru Comfort seat cushion. Not available on the flip down bracket.

MISCELLANEOUS POSITIONING COMPONENTS

Description	Price	HCPCS Code
<input type="checkbox"/> Therafin Flip-down Knee Abductor Bracket ^{1*}	\$172	E1028
Pad:		
<input type="checkbox"/> Small <input type="checkbox"/> Medium <input type="checkbox"/> Large	\$135	E0957
<input type="checkbox"/> Stealth Foot Boxes (pair) [*]	\$475	K0108
<input type="checkbox"/> Small <input type="checkbox"/> Medium <input type="checkbox"/> Large		
<input type="checkbox"/> Stealth Padded Shoe Holders (pair) [*]	\$166	K0108
<input type="checkbox"/> Small <input type="checkbox"/> Medium <input type="checkbox"/> X-Large		
<input type="checkbox"/> Otto Bock Arm Channels (ea.) [*]	\$104	E2209
Side:		
<input type="checkbox"/> Left <input type="checkbox"/> Right		
Size:		
<input type="checkbox"/> Small <input type="checkbox"/> Medium <input type="checkbox"/> Large		
<input type="checkbox"/> Otto Bock Flat Hand Pad(ea.) [*]	\$52	
Side:		
<input type="checkbox"/> Left <input type="checkbox"/> Right		
Size:		
<input type="checkbox"/> Medium <input type="checkbox"/> Large		

Please see positioning components order form for additional types, sizes and details.

1. Not available with high mount foot platform.

ACCESSORIES

Description	Price	HCPCS Code
<input type="checkbox"/> Rear Basket ¹	\$103	
<input type="checkbox"/> Cane/Crutch Holder ¹	\$98	E2207
<input type="checkbox"/> Weather Cover, Medium, Black	\$158	
<input type="checkbox"/> Cup Holder	\$17 ²	
Side:		
<input type="checkbox"/> Left <input type="checkbox"/> Right		
<input type="checkbox"/> Saddle Bag	\$28	
<input type="checkbox"/> Flag Holder	\$17	
<input type="checkbox"/> Quantum Backpack ³	\$60	
<input type="checkbox"/> Oxygen Holder Contoured Seating ¹	\$103	E2208
<input type="checkbox"/> Oxygen Holder Synergy Seat ⁴	\$150	E2208
<input type="checkbox"/> Walker Holder ⁴	\$92	K0108
<input type="checkbox"/> Tablet Holder ⁵	\$315	
<input type="checkbox"/> Deluxe Cell Phone/Media Holder ⁵	\$140	
<input type="checkbox"/> Cell Phone/Media Holder ⁵	No Charge	

1. Includes mounting hardware. Not available on Manual Recliner.
2. No charge on Synergy Seating.
3. Backpack may interfere w/ other rear accessories. Not available w/ contoured seating.
4. Not available with Synergy manual recline or manual tilt. Includes mounting hardware.
5. Only available with Synergy or Specialty seating.

Items marked with a (*) should be chosen in the Positioning Components screen in iQuantum

Options with a circular checkbox (☐) are NOT available through Quantum West.

LAPBELTS

Description	Price
<input type="checkbox"/> 38" Lap Belt ¹	Standard
<input type="checkbox"/> 50" Lap Belt ¹	Standard
<input type="checkbox"/> 60" Lap Belt	Standard
<input type="checkbox"/> 60" Non-Retractable (Sure-Lok) ²	Standard
<input type="checkbox"/> 70" Lap Belt	Standard
<input type="checkbox"/> 80" Lap Belt	Standard
<input type="checkbox"/> 90" Lap Belt	Standard
<input type="checkbox"/> Pelvic Positioning Belt, 2-Point Padded Med, 9"-15" Hip Width*	\$87
<input type="checkbox"/> Pelvic Positioning Belt, 2-Point Padded, Lg, 13"-19" Hip Width*	\$92
<input type="checkbox"/> Pelvic Positioning Belt, 4-Point Padded, Med, 9"-15" Hip Width*	\$112
<input type="checkbox"/> Pelvic Positioning Belt, 4-Point Padded, Lg, 13"-19" Hip Width*	\$116

1. Includes mounting hardware. Not available with Manual Recliner.
 2. Only needed with the occupied transit kit.

BATTERY OPTIONS

Description	Price	HCPCS Code
<input type="checkbox"/> NF-22, 50-Amp Batteries		
<input type="checkbox"/> Maintenance Free AGM	\$255 ea.	E2361
<input type="checkbox"/> Maintenance Free Gel Cell (Universal)	\$295 ea.	E2361
<input type="checkbox"/> Maintenance Free Gel Cell (MK)	\$295 ea.	E2361
Installation:		
<input type="checkbox"/> Batteries Installed <input type="checkbox"/> Do Not Install		

VENT TRAY (SYNERGY SEAT ONLY)

Description	Price
<input type="checkbox"/> Compact Vent Tray	\$1,395
<i>The addition of a compact vent tray may increase the length & weight of your power chair.</i>	
Mounting Bracket:	
<i>Bracket is pre-selected with TRU-Comfort Back</i>	
<input type="checkbox"/> Flush	<input type="checkbox"/> 3" Offset ¹ <input type="checkbox"/> 6" Offset

- Accommodates Pulmonetics LTV-style ventilators.
 - Max Vent Dim. 3.25" H x 10.5" W x 13.5" / 20 lbs.
 - Not Available with Power Elevating Seat, Shape Back, Sling Back, Manual Recline, Manual Tilt, Flip Down Back Canes or rear mounted accessories.

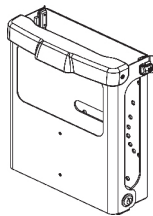

1. Not available with Flip-Up Armrests.

TRANSIT KIT INFO

Q600

THIS SECTION MUST BE READ

The Transit Securement Package, when used in conjunction with a wheelchair in the specific configuration of a 18"x20" seat size, with 25" high back canes, Full-length height-adjustable single post armrests, Synergy back 25"h, and style 8 swing away legrests and extruded footplates and heel-loops, conforms with the standard of ANSI/RESNA WC/Vol. 4, Section 19, for the purpose of enabling wheelchairs to be secured in certain types of motor vehicles. The Transit Securement Package, including manufacturer-installed front and rear securement brackets and pelvic belt anchoring brackets, has been crash tested in accordance with ANSI/RESNA WC/Vol. 4, Section 19, Frontal Impact Test, with a 168-lbs. (76.2 kg) surrogate occupant corresponding to a user weight range of 115 lbs. (52.16 kg) to 210 lbs. (95.25 kg). While the Transit Securement Package is compatible with additional seat sizes, optional components, and varied configurations, and provides designated securement points, Pride Mobility makes no claims that any other components or configurations have been tested beyond the above described ANSI/RESNA conforming configuration. Please refer to the Transit Securement Package supplement (part number INFMANU3658) for additional information.

RULES:

- All options are available when unoccupied.
- Notes when selecting occupied transit kit:**
- It is recommended that usable back height be 2" lower than shoulder height.
- Available on Synergy Seat up to 20W x 20D
- Power AFP, ALRs & ELRs are available on Synergy Seating
- All legrests must have heel loops
- Synergy manual seating is N/A
- TRU-Balance Power Positioning seating, options and accessories are N/A
- TRU-Comfort seat cushion is N/A
- Contoured seating is N/A
- Specialty seating is N/A
- Vent option is N/A
- Omit Back option is N/A

Items marked with a (*) should be chosen in the Positioning Components screen in iQuantum