



Basic Operation Instructions



NE+

Identification Key

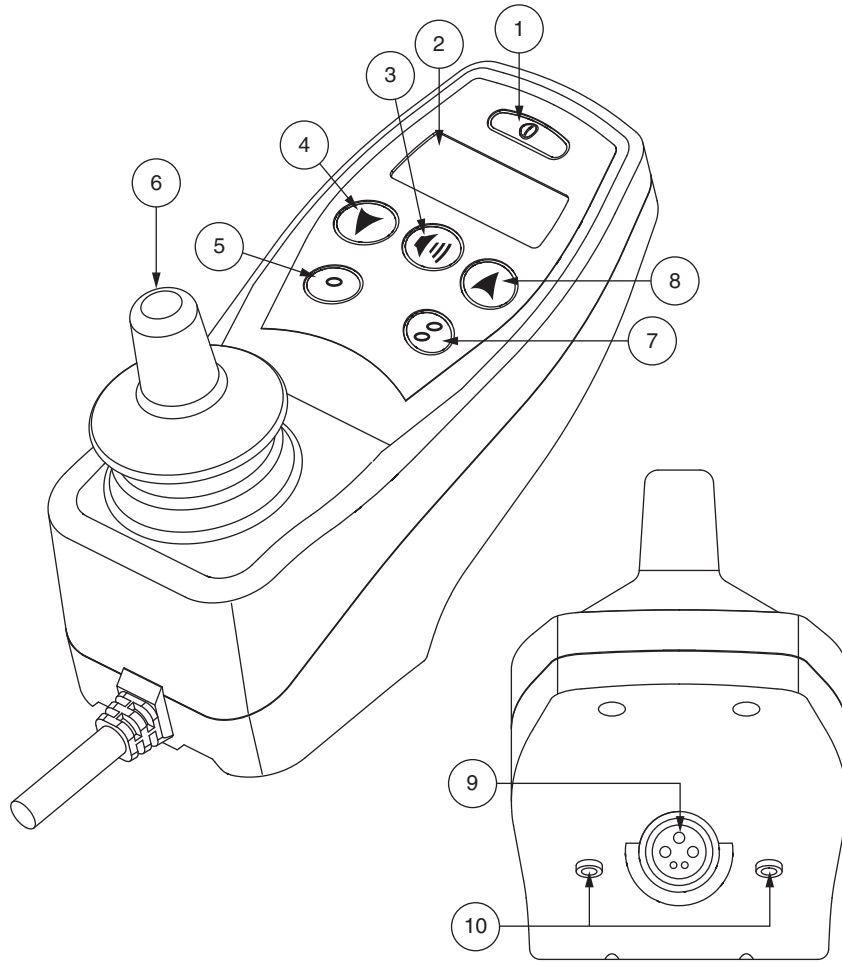

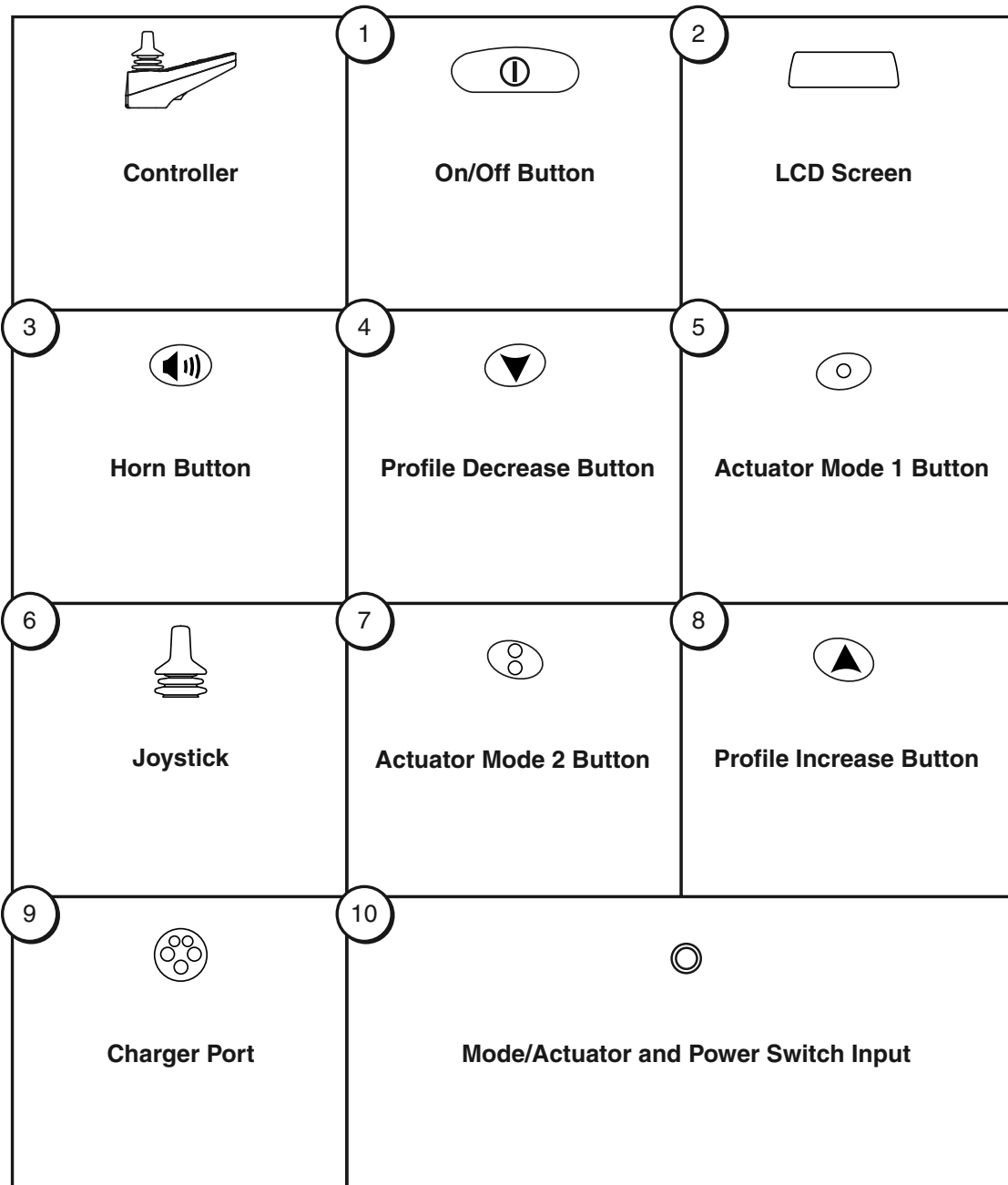

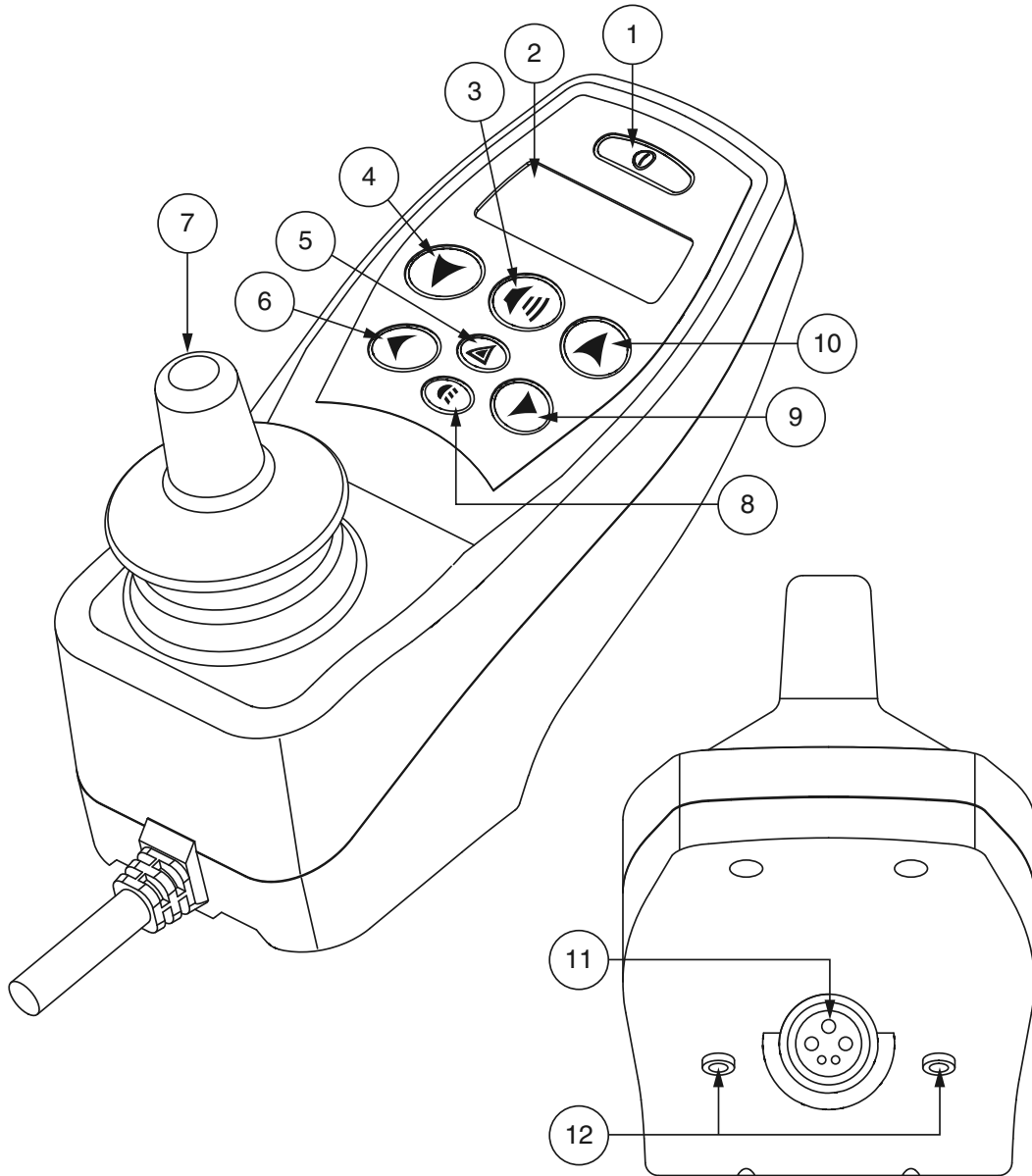

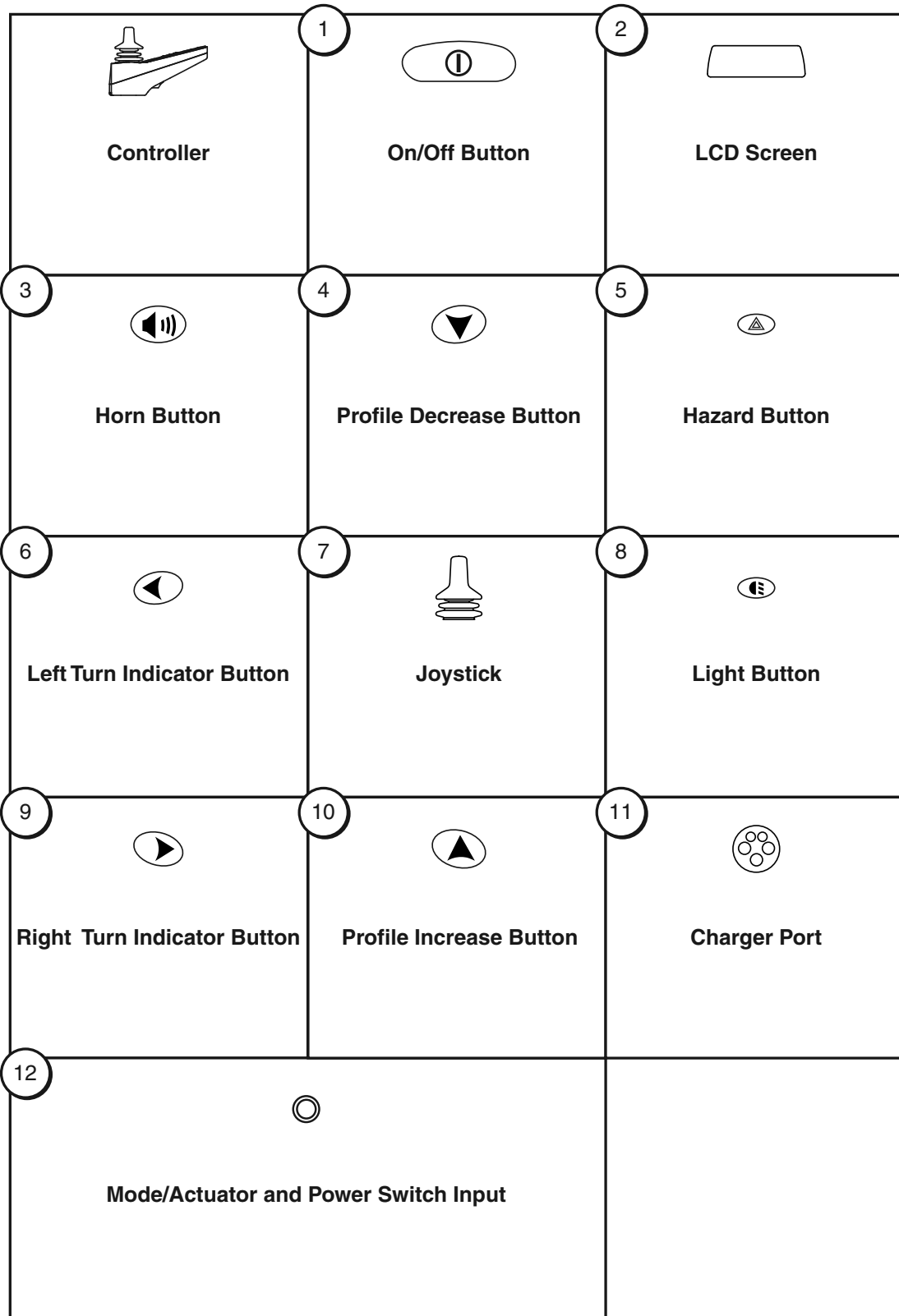

Identification Key

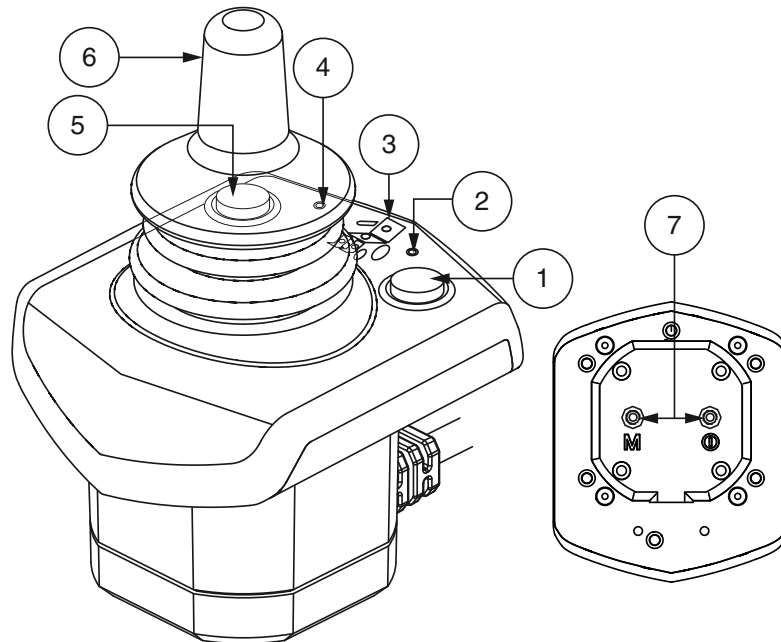
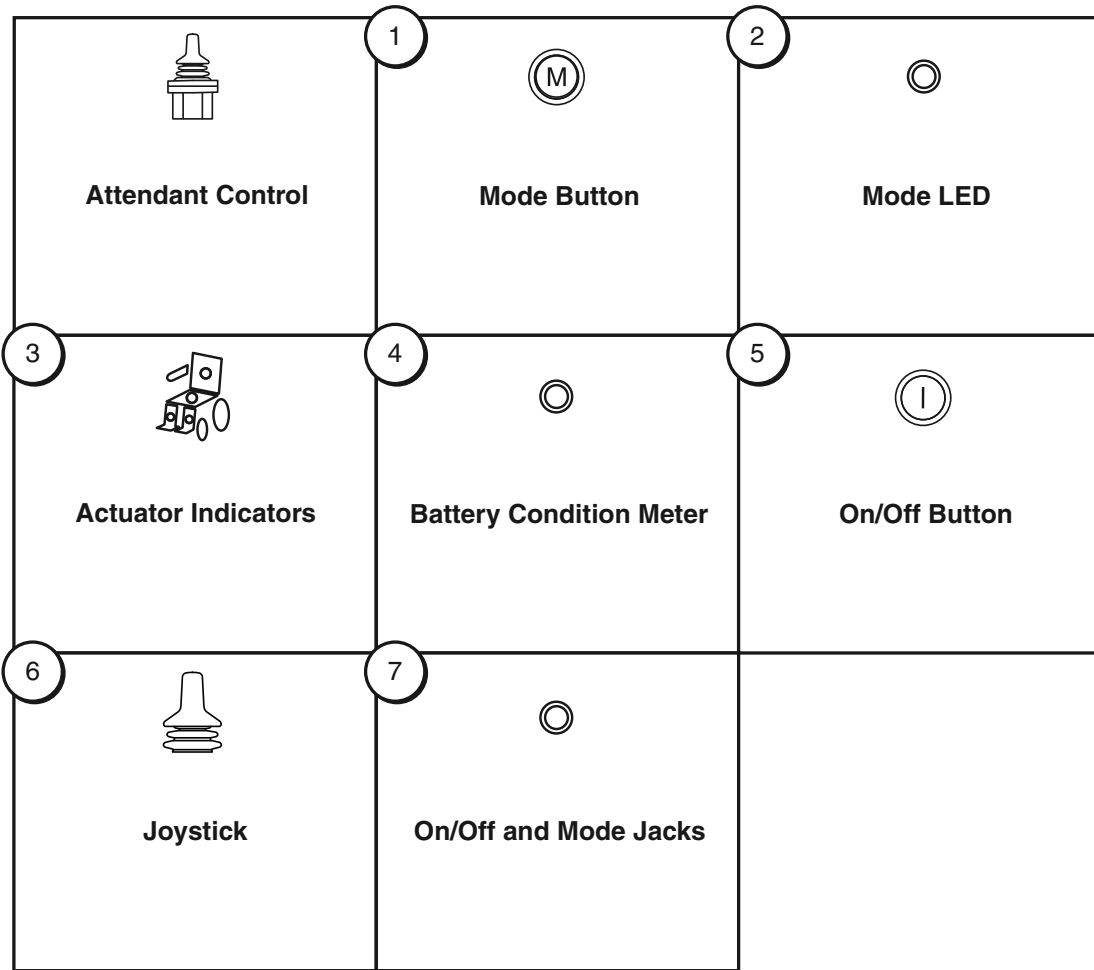



WARNING! A Quantum Rehab Provider or a qualified technician must perform the initial setup of this product and must perform all of the instructions in this manual.

The symbols below are used throughout this owner's manual and on the controller to identify warnings and important information. It is very important for you to read them and understand them completely.



WARNING! Indicates a potentially hazardous condition/situation. Failure to follow designated procedures can cause either personal injury, component damage, or malfunction. On the product, this icon is represented as a black symbol on a yellow triangle with a black border.



MANDATORY! These actions should be performed as specified. Failure to perform mandatory actions can cause personal injury and/or equipment damage. On the product, this icon is represented as a white symbol on a blue dot with a white border.



PROHIBITED! These actions are prohibited. These actions should not be performed at any time or in any circumstances. Performing a prohibited action can cause personal injury and/or equipment damage. On the product, this icon is represented as a black symbol with a red circle and a red slash.

NOTE: *These instructions are compiled from the latest specifications and product information available at the time of publication. We reserve the right to make changes as they become necessary. Any changes to our products may cause slight variations between the illustrations and explanations in this manual and the product you have purchased. The latest/current version of this manual is available on our website.*

NOTE: *This product is compliant with WEEE, RoHS, and REACH directives and requirements.*

NOTE: *This product meets IPX4 classification (IEC 60529).*

NOTE: *The NE+ Controller and its components are not made with natural rubber latex. Consult with the manufacturer regarding any after-market accessories.*

Label Information	9
NE+ Controller	10
Precautionary Guidelines	10
Operating the NE+ Controller	10
Joystick	10
Keypad.....	10
On/Off Button.....	10
Horn Button.....	10
LCD Screen	11
Drive Profile Selection	11
Battery Condition Meter.....	12
Right/Left Turn Indicator Buttons (for Optional Equipment)	12
Light Button (for Optional Equipment).....	12
Hazard Button (for Optional Equipment).....	12
Power Accessory Indicators (for Optional Equipment)	12
Controller Connector	12
Off-Board Charger/Programming Socket.....	12
Speed Adjustment/Profile Select	12
Actuator Adjustment	13
Attendant Control Joystick.....	14
Lock Mode.....	14
Sleep Mode	14
Thermal Rollback	14
NE+ Error Codes	15
Care and Maintenance	17
Temperature	17
Warranty	17

Product Safety Symbols

The symbols below are used on the controller to identify warnings, mandatory actions, and prohibited actions. It is very important for you to read and understand them completely.



Read and follow the information in the owner's manual.



Avoid exposure to rain, snow, ice, salt, or standing water whenever possible. Maintain and store in a clean and dry condition.



EMI/RFI—This product has been tested and passed at an immunity level of 20 V/m.



Disposal and recycling—Contact your Pride/Quantum Rehab Provider for information on proper disposal and recycling of your Pride product and its packaging.

NE+ Controller

The NE+ controller is a fully programmable, modular electronic controller system that allows you to operate your power chair. It is designed to allow the user to have complete control over chair movement and speed.

The controller has been pre-programmed to meet a typical user's needs. The program is set using either a personal computer with software provided by the controller manufacturer or with a hand-held programmer, also provided by the controller manufacturer.



WARNING! The controller program can affect speed, acceleration, deceleration, dynamic stability, and braking. If it is programmed incorrectly or outside of the safe limits as determined by your healthcare professional, it can create a dangerous situation. Only the power chair manufacturer, an authorized representative of the manufacturer, or a trained service technician should program the controller.

Precautionary Guidelines

Before operating the NE+ controller, please read the following. These guidelines are provided for your benefit and will aid you in the safe operation of the controller system.

- Turn off the power to the controller when transferring to or from your power chair.
- Follow all of the procedures and heed the warnings as explained in your power chair owner's manual.

Operating the NE+ Controller

The NE+ controller is used to operate your power chair and all of its components.

The NE controller consists of:

- Joystick
- Keypad
- Off-board charger/programming socket
- Controller connector
- Power module

Joystick

The joystick controls the direction and speed of your power chair. When you move the joystick from the neutral (center) position, the electromagnetic brakes release and allow your power chair to move. The farther you push the joystick from its neutral position, the faster your power chair moves. When you release the joystick and allow it to return to the neutral position, you engage the electromagnetic brakes. This causes your power chair to decelerate and come to a complete stop.

Keypad

The keypad is located directly in front of the joystick. It contains keys that you will use to control your power chair.

On/Off Button

The on/off key turns the system on and off.



WARNING! When faced with an emergency stop situation, release the joystick, then press the on/off to stop the power chair. Use caution. Be advised that pressing the on/off button may cause the power chair to stop abruptly.

WARNING! Always turn the power off when you are stationary to prevent unexpected movement.

Horn Button

The horn button activates a warning horn.

LCD Screen

The LCD screen provides the user with easily intuited feedback information such as battery condition, key lock, actuator indicators, turn indicators, power chair speed, warnings, and error codes. **See figure 1.**

The brake, fault, warning, power base, and temperature warning indicators are only lit when the system detects a condition that triggers them. If a warning indicator is displayed, the controller will also give an audible beep.

The charging and lights indicators are lit steadily when the corresponding function is active. When these indicators are flashing, they indicate the location of a problem. See Error Codes.

The turn indicators flash as the turn indicator lights are flashing. If there is a problem, the warning icon will light and the turn indicator will flash at twice its normal rate.

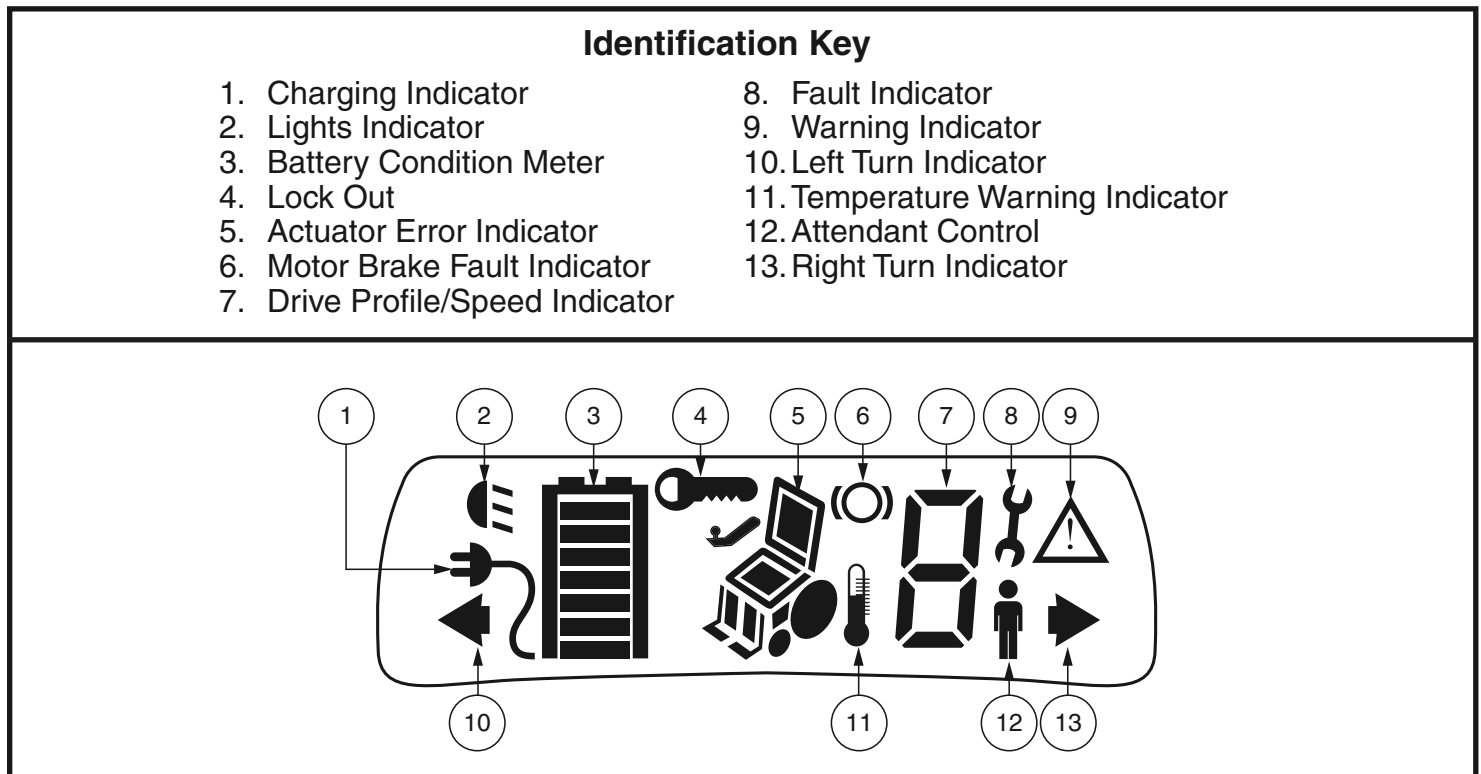

Figure 1. LCD Screen

Drive Profile Selection

Your NE+ controller may be programmed for up to five drive profiles that allow the system to be custom tailored to your environment. The drive profile may be changed by pressing the profile decrease key or the profile increase key.

NOTE: Drive profiles are set by your Pride/Quantum Rehab Provider. Contact your Quantum Rehab Provider to change or add a drive profile.

Battery Condition Meter

The battery condition meter consists of a 7-segment display on the LCD. As the battery voltage drops, the number of lights reduces from top to bottom. When the battery capacity drops to 10% or below, the bottom segment will flash.

- **Bottom Segment Flashing:** The battery charge is low; charge the batteries as soon as possible.
- **Upward Ripple of Segments with Charging Plug:** The controller is in charging mode.
- **All or No Segments Flashing Quickly (Code):** The controller has detected a fault; refer to the Error Code table.

Right/Left Turn Indicator Buttons (for Optional Equipment)

The right/left turn indicator buttons toggle either the left or right turn indicators. Press once to turn on and press again to turn off. You can also turn off the selected turn indicator by pressing the opposite indicator button or the hazard button.

Light Button (for Optional Equipment)

The light button turns the headlights/taillights on and off independent of other indicators.

Hazard Button (for Optional Equipment)

The hazard key activates both turn indicators at the same time. You can cancel this only by pressing the hazard button again.

Power Accessory Indicators (for Optional Equipment)

Indicates the selected power accessory. This is only for optional accessories.

NOTE: If your power chair is equipped with power accessories such as a power elevating seat or power elevating leg rests, you can operate them through the keypad buttons, joystick, mono jack switch, and attendant control. Refer to “Actuator Adjustment.”

Controller Connector

This connects the NE+ controller to the power module located on the power base.

Off-Board Charger/Programming Socket

You may use an off-board charger to charge the power chair batteries through the 5-pin socket located on the front of the NE+ controller. If you use an off-board charger, the charger current should not exceed 8 amps. Contact your Pride/Quantum Rehab Provider for more information.



WARNING! Only chargers with Neutrik NC3MX plugs should be connected to the off-board charger/programming socket. See your Pride/Quantum Rehab Provider for more information.

NOTE: The socket may also be used for reprogramming the NE+ controller. Contact your Pride/Quantum Rehab Provider for more information.

Speed Adjustment/Profile Select

To select a speed setting or drive profile:

1. Press the on/off button to power on the controller.
2. Press the drive profile decrease or drive profile increase button until you reach the desired speed/profile setting.

NOTE: Drive profiles are set by your Pride/Quantum Rehab Provider. Contact your Pride/Quantum Rehab Provider to change a drive profile or change speed settings.

Actuator Adjustment

The NE+ controller can control up to two actuators by using the actuator buttons; using the profile decrease button and/or the profile increase button and the joystick; using a switch in the mono jack; or using the attendant control. The active actuator is indicated by the darkened section of the seat on the display. **See figure 2.**

To select and adjust an actuator using the actuator buttons:

1. Press the on/off button to power on the controller.
2. Press one of the actuator buttons.
3. Hold the actuator button down to raise the actuator to the desired position, then release.
4. Press and hold the actuator button again to lower the actuator.

NOTE: You can simultaneously drive the power chair and operate the actuators until the actuator's preset drive lockout is reached.

To select and adjust an actuator using the decrease and increase profile buttons:

1. Press the on/off button to power on the controller.
2. Press either the profile decrease or increase button until you reach actuator mode.
3. Push the joystick to the right or left to cycle through the available actuators. The actuator indicators will display which actuator is activated.
4. When the desired actuator is selected, give a forward command to the joystick to lower the actuator or give a reverse command to the joystick to raise the actuator.

To select and adjust an actuator using the mono jack switch:

1. Press the on/off button to power on the controller.
2. Press the switch plugged into the mode/actuator jack.
3. Hold the switch to raise the actuator to the desired position, then release.
4. Press and hold the switch again to lower the actuator.

NOTE: Function of the mono jack on the joystick is set by your Pride/Quantum Rehab Provider. Contact your Pride/Quantum Rehab Provider to change the function of the jack. (For two actuators, a splitter harness will be needed.)

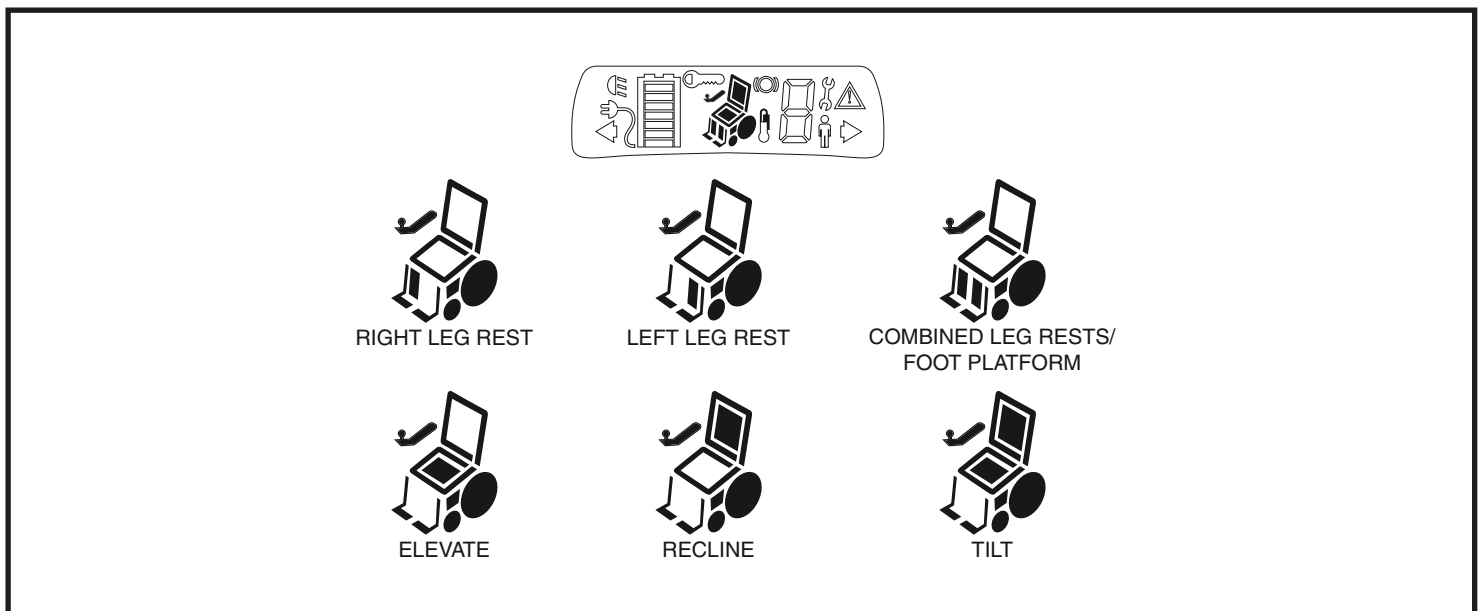

Figure 2. Actuator Selection

Attendant Control Joystick

For more information on this application, contact your Pride/Quantum Rehab Provider.

The Attendant Control is for use by an ambulatory attendant and has the following controls:

- On/Off Button
Enables/disables power
- Battery Condition Meter
Indicates battery charge
- Actuator LEDs
Indicates actuators in use
- Mode LED
Used for profile selection
- Joystick
Controls speed and direction in Drive mode; selects actuators in Seat mode.

NOTE: When in use, the Attendant Control overrides hand control commands.

Lock Mode

This controller can have a feature enabled that allows you to “lock out” unauthorized users.

To lock the controller:

1. Press and hold both profile keys until the system shuts off.
2. The system is now locked.

NOTE: When the system is turned on and the system is locked, the battery condition meter and a key will be on the screen. (See NE+ Error Codes.)

To unlock the controller:

1. Press the on/off key to turn on the controller. The battery condition meter and a key will be displayed on the screen.
2. Move the joystick to the full forward position until the controller beeps.
3. Move the joystick to the full reverse position until the controller beeps.
4. Release the joystick. The controller is now unlocked.

Sleep Mode

The NE+ controller offers a sleep mode feature which will shut off the main power if the joystick remains stationary for a programmed period of time from 0-240 minutes. To restore power and resume operation of the chair, push the on/off key.

Thermal Rollback

The NE+ controller is equipped with a thermal rollback circuit which monitors the temperature of the chair’s motors and controller. If either exceeds the safe operating temperature, the controller reduces the output to 20% of full operation level. This reduces the chair’s speed and allows a cool down period. Once the temperature returns to a safe level, the chair will resume normal operation.

NE+ Error Codes

The NE+ displays four types of messages: information, warning, temperature, and fault.

- **Information:** Displays information about the power chair's functionality or performance. There is no icon associated with an information message.
- **Warning:** Alerts you to conditions that may affect power chair functionality and performance. **See figure 1.**
- **Temperature:** Alerts you to conditions relating to the temperature of your power chair components that can affect functionality and performance. **See figure 1.**
- **Fault:** Alerts you to conditions that influence power chair functionality and performance.

Error codes are displayed on the LCD as icons. The following table identifies the error codes that may be easily rectified along with their probable causes and possible solutions. If you receive one of these error codes, follow the recommended solution. If the problem persists or you receive any other error code or experience any other problem with your power chair, contact your Pride/Quantum Rehab Provider.

*If the fault does not reset after performing the solution, contact your Pride/Quantum Rehab Provider.







Icon Display	Diagnosis	Solution
	Power Section Fault	Cycle power. Check power module and joystick module connections and wiring.*
	Joystick Not Centered	Release joystick and make sure the joystick is in center position. Power off and on again. Check connections.*
	Communications Fault	Check joystick cable connections.*
	Motor/Brake Fault	Check motor/brake connectors.*
	Low Battery Voltage	Charge batteries. This may take 12 to 14 hours to fully charge the batteries.
	High Battery Voltage	Disconnect charger.
	Drive Thermal Warning	Allow motor to cool.*
	Open Motor Fault	Check motor connectors.*

Table 1: NE+ Error Codes

*If the fault does not reset after performing the solution, contact your Pride/Quantum Rehab Provider.



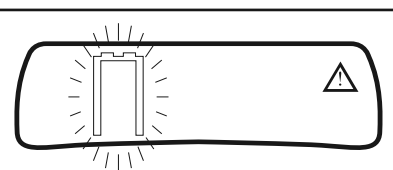
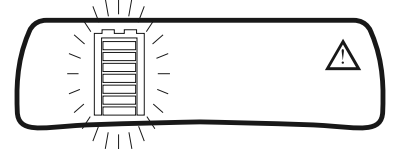



Icon Display	Diagnosis	Solution
	Left Indicator Fault	Press left indicator key.*
	Right Indicator Fault	Press right indicator key.*
	Hazard Indicator Fault	Press hazard key.*
	Running Lights Fault	Press light key.*
	Speed Limit Warning	Return seat to normal or upright position.*
	Low Battery	Charge batteries. This may take 12 to 14 hours to fully charge the batteries.
	Battery Charging Inhibit: Joystick powered on	Unplug charger when charging is complete.
	Battery Charging Inhibit: Joystick powered off	Unplug charger when charging is complete.
	Idle Mode	Cycle power. If it continues, contact your Pride/Quantum Rehab Provider.
	Attendant Control Fault	Check Attendant Control connections and wiring.*
	NE+ Controller is locked out	Unlock controller. See Lock Mode in Table of Contents.

Table 1: NE+ Error Codes

Care and Maintenance

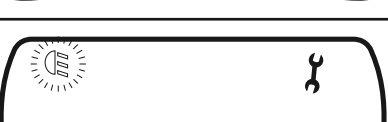
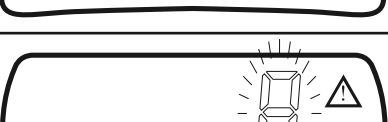
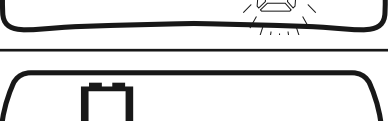
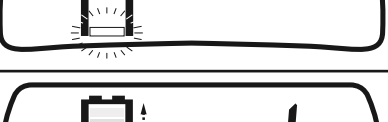
Refer to your power chair owner's manual for proper cleaning and disposal instructions.

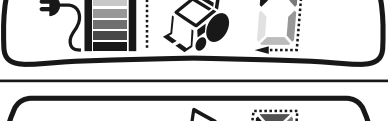
Temperature

Some parts of your power chair are susceptible to extreme changes in temperature. Always keep your power chair between the temperature of 18°F (-8°C) and 122°F (50°C).

Warranty

Refer to your power chair owner's manual for specific information on controller warranty.



USA

401 York Avenue
Duryea, PA 18642

Canada

5096 South Service Road
Beamsville, Ontario L0R 1B3

UK

32 Wedgwood Road
Bicester, Oxfordshire OX26 4UL
www.quantumrehab.co.uk

Australia

20-24 Apollo Drive
Hallam, Victoria 3803
www.quantumrehab.com.au

New Zealand

38 Lansford Crescent
Avondale
Auckland, New Zealand 1007
www.pridemobility.co.nz

Italy

Via del Progresso, ang. Via del Lavoro
Loc. Prato della Corte
00065 Fiano Romano (RM)
www.quantumrehab-italia.it

B.V.

Castricummer Werf 26
1901 RW Castricum
The Netherlands
www.quantumrehab.eu

www.quantumrehab.com

