

**Quantum® Q1121 Series**

Group 3 Standard

Order Form

300 lbs. weight capacity



Account Number: \_\_\_\_\_

Provider Name: \_\_\_\_\_

Contact: \_\_\_\_\_

Phone: \_\_\_\_\_

Fax: \_\_\_\_\_

Date: \_\_\_\_\_

PO#: \_\_\_\_\_

Marked For: \_\_\_\_\_

Ship To: \_\_\_\_\_

Address: \_\_\_\_\_

City: \_\_\_\_\_ State: \_\_\_\_\_ Zip: \_\_\_\_\_

Discount: \_\_\_\_\_

Terms: \_\_\_\_\_

Freight: \_\_\_\_\_

Taken By: \_\_\_\_\_

**SET-TO-SPEC\***

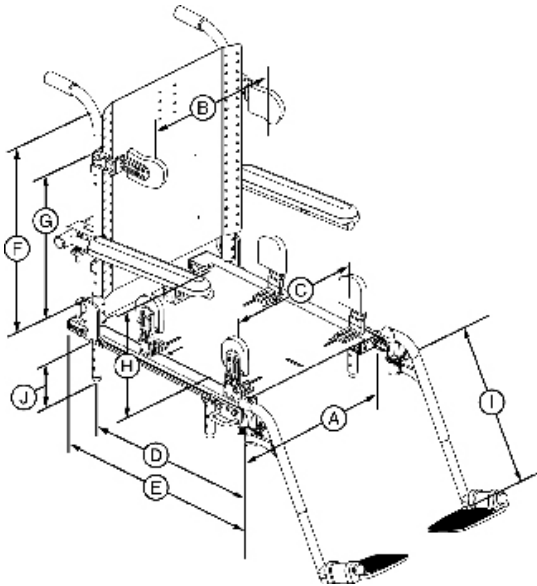

Client Height: \_\_\_\_\_

Client Weight: \_\_\_\_\_

A. Seat Width: \_\_\_\_\_

B. Lateral Offset: \_\_\_\_\_

C. Hip/Thigh Lateral Offset: \_\_\_\_\_

D. Center of Gravity: *Optimized based on seat dimensions*

E. Seat Depth: \_\_\_\_\_

F. Back Height from Pan: \_\_\_\_\_

G. Lateral Height from Pan: \_\_\_\_\_

H. Armrest Height from Pan: \_\_\_\_\_

I. Rigging Length (whole numbers only): \_\_\_\_\_

J. Seat to Floor Height (circle one): \_\_\_\_\_

Seating System	Seat-To-Floor Heights		
	21"	22"	23"
Contoured Seating	21"	22"	23"
Specialty Seating	16.75"	17.75"	18.75"
Synergy® Seat	16.625"	17.625"	18.625"
Synergy Seat (Extended Stem Mounts)	18.625"	19.625"	20.625"

*Seat to floor height are +/- 1/8" with 18"W x 18"D with Flat-Free tires (add 3/8" for pneumatic tires). Increased widths may increase lowest seat to floor heights.*

Clinician Notes: \_\_\_\_\_

\_\_\_\_\_  
\_\_\_\_\_  
\_\_\_\_\_  
\_\_\_\_\_  
\_\_\_\_\_

\* While every effort will be taken to ensure items will be preset to your specifications prior to shipping, variations in options may effect final settings.

*DME providers are responsible for determining appropriate billing codes when submitting for insurance reimbursement.*

*HCPCS codes should not be considered as legal advice. All prices are MSRP.*

**BASE MODEL** **EXPANDABLE CONTROLS (cont.)**

Description	Price	HCPCS Code
<input type="checkbox"/> Quantum 1121 3SP-C	\$6,201	<i>Call Reimbursement For Coding</i>
<input type="checkbox"/> Quantum 1121 3SP-SS <i>An SP-C describes a base with an alternative drive device with a captain's seat</i>	\$6,201	

**COLOR**

<input type="checkbox"/> Champagne	<input type="checkbox"/> Onyx Black
<input type="checkbox"/> Candy Apple Red	<input type="checkbox"/> Sunburst Orange
<input type="checkbox"/> Viper Blue	

**DRIVE WHEELS**

Description	Price
<input type="checkbox"/> 14" Flat-Free	Standard
<input type="checkbox"/> 14" Pneumatic	No Charge

**BATTERY CHARGER**

Description	Price
<input type="checkbox"/> 8 Amp, Off-board Charger	Standard



**BASE MOUNTED FOOT PLATFORM**

<input type="checkbox"/> No Base Mounted Front Platform	No Charge
<input type="checkbox"/> Base Mounted Foot Platform	Standard
<input type="checkbox"/> 9.5"D	<input type="checkbox"/> 11.62"D



**POWER ELEVATING SEAT**



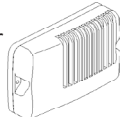

Description	Price
<input type="checkbox"/> Power Elevating Seat <sup>1</sup>	\$975
<input type="checkbox"/> Through Toggle	
<input type="checkbox"/> Left Side	<input type="checkbox"/> Right Side
<input type="checkbox"/> Through Joystick <i>(See Electronics for Power Options on Pg. 5)</i>	

**NON-EXPANDABLE CONTROLS**

Description	Price
<input type="checkbox"/> P&G VSI 70 amp 	No Charge
<input type="checkbox"/> P&G 6-Key VSI 70 amp 	\$200 <i>Standard on 3SP- C Package</i>

**EXPANDABLE CONTROLS**

Description	Price	HCPCS Code
<b>All Joysticks or Omni Plus must be used in conjunction with a PG Controller and Harness for Expandable Controller</b>		
<input type="checkbox"/> P&G Controller 	\$695	E2377
<input type="checkbox"/> Harness For Expandable Controller	\$350	E2313
<input type="checkbox"/> 3-Key Remote Plus Joystick, 70 amp <input type="checkbox"/> 1 Profile <input type="checkbox"/> Multiple Profile 	\$700	
<input type="checkbox"/> Remote Plus Joystick, 70 amp with Speed Dial 	\$700	

Description	Price
<input type="checkbox"/> Remote Plus Joystick, 70 amp with Toggles 	\$700
<input type="checkbox"/> Remote Plus Joystick, 70 amp with Switch Jacks 	\$700
<input type="checkbox"/> 7-Key Remote Plus Joystick, 70 amp <input type="checkbox"/> 1 Profile <input type="checkbox"/> Multiple Profile <i>Required For LED Light Package</i> 	\$700
<input type="checkbox"/> Micro Drive Joystick, 70 amp <sup>2</sup> 	\$700
<input type="checkbox"/> Omni Plus <sup>3</sup> 	\$1,721.63

**PROGRAMMING**

Description	Price
<input type="checkbox"/> P&G Handheld Programmer 	\$423

**JOYSTICK MOUNTING BRACKETS**

Description	Price	HCPCS Code
<i>Comes Standard with a Quick Release, Adjustable-Height Joystick Block</i>		
<input type="checkbox"/> Fixed Inline	Standard	
<input type="checkbox"/> Left	<input type="checkbox"/> Right	
<input type="checkbox"/> Swing-away	\$210	E1028
<input type="checkbox"/> Left	<input type="checkbox"/> Right	
<input type="checkbox"/> Inline	<input type="checkbox"/> Offset	
<input type="checkbox"/> 4" Ext.	<input type="checkbox"/> 7" Ext.	
<input type="checkbox"/> Multi-axis Fixed	\$100	K0108
<input type="checkbox"/> Left	<input type="checkbox"/> Right	

**JOYSTICK HANDLES**

Description	Price	HCPCS Code
<input type="checkbox"/> Standard Knob	Standard	
<input type="checkbox"/> Mushroom Handle	\$71	E2323
<input type="checkbox"/> T-Bar	\$107	E2323
<input type="checkbox"/> Chin Cup	\$71	E2324 <sup>4</sup>
<input type="checkbox"/> Extended I-Handle	\$71	E2323
<input type="checkbox"/> Soft Ball Handle	\$50	E2323
<input type="checkbox"/> Medium Ball Handle	\$50	E2323
<input type="checkbox"/> Bodypoint 3" Goal Post Handle	\$69	E2323
<input type="checkbox"/> Bodypoint 4" Goal Post Handle	\$69	E2323

**FOOTNOTES**

1. Not available with Manual Recliner, Synergy Manual Recline or Synergy Manual Tilt. Maximum seat size 20"W x 20"D. Increases STF Height. Includes 1/4 speed inhibit.
2. Requires multi-axis joystick mount, no charge.
3. See Specialty Electronics order form for additional mounting options and secondary controls.
4. Use HCPCS code E2323 when not used in conjunction with chin control.

**CONTOURED SEATING**

Description	Price	HCPCS Code
<b>Medium Back:</b>		
<input type="checkbox"/> Med-Back	No Charge	
<input type="checkbox"/> Med-Back with Solid Seat Pan <sup>1</sup>	No Charge	
<b>Seat Width:</b>		
<input type="checkbox"/> 16" <input type="checkbox"/> 18" <input type="checkbox"/> 20"		
<b>Seat Depth:</b>		
<input type="checkbox"/> 16" <input type="checkbox"/> 18" <input type="checkbox"/> 20"		
<b>Upholstery:</b>		
<input type="checkbox"/> Black Vinyl <input type="checkbox"/> Beige Vinyl <input type="checkbox"/> Gray Fabric		
<input type="checkbox"/> Gray Vinyl <input type="checkbox"/> Brown Fabric <input type="checkbox"/> Brown Vinyl		
<b>High Back:</b>		
<input type="checkbox"/> Limited Recline High-Back with Headrest	No Charge	
<input type="checkbox"/> Limited Recline High-Back with Headrest & Solid Seat Pan <sup>1</sup>	No Charge	
<b>Seat Width:</b>		
<input type="checkbox"/> 16" <input type="checkbox"/> 18" <input type="checkbox"/> 20"		
<b>Seat Depth:</b>		
<input type="checkbox"/> 16" <input type="checkbox"/> 18" <input type="checkbox"/> 20" <input type="checkbox"/> 22"		
<b>Upholstery:</b>		
<input type="checkbox"/> Black Vinyl <input type="checkbox"/> Beige Vinyl <input type="checkbox"/> Gray Fabric		
<input type="checkbox"/> Gray Vinyl <input type="checkbox"/> Brown Fabric		
<b>Armrests:</b>		
<input type="checkbox"/> Flip-Up, Removable	No Charge	
<input type="checkbox"/> Flip-Up, Height-Adjustable, Removable	\$85 ea.	E0973
<b>Armpads:</b>		
Left: <input type="checkbox"/> Full Length <input type="checkbox"/> Desk Length		
Right: <input type="checkbox"/> Full Length <input type="checkbox"/> Desk Length		

**MANUAL RECLINER**

Description	Price	HCPCS Code
<input type="checkbox"/> Manual Recliner High Back with Headrest	\$600	E1226
<input type="checkbox"/> Manual Recliner High Back with Headrest and Solid Seat Pan <sup>1</sup>	\$600	E1226
<b>Upholstery:</b>		
<input type="checkbox"/> Beige Vinyl <input type="checkbox"/> Gray Vinyl		
<b>Seat Width:</b>		
<input type="checkbox"/> 16" <input type="checkbox"/> 18" <input type="checkbox"/> 20"		
<b>Seat Depth:</b>		
<input type="checkbox"/> 16" <input type="checkbox"/> 18" <input type="checkbox"/> 20"		
<b>Armpads:</b>		
Left: <input type="checkbox"/> Full Length <input type="checkbox"/> Desk Length		
Right: <input type="checkbox"/> Full Length <input type="checkbox"/> Desk Length		

**SPECIALTY SEAT**

Description	Price	HCPCS Code
<input type="checkbox"/> Specialty Seat Kit	No Charge	
<b>Seat Width:</b>		
<input type="checkbox"/> 16" <input type="checkbox"/> 18" <input type="checkbox"/> 20"		
<b>Seat Depth:</b>		
<input type="checkbox"/> 16" <input type="checkbox"/> 17" <input type="checkbox"/> 18" <input type="checkbox"/> 19"		
<input type="checkbox"/> 20"		
<b>Back Cane Height:</b>		
<input type="checkbox"/> 18" <input type="checkbox"/> 20" <input type="checkbox"/> 22"		
<b>Back Rest Height:</b>		
<input type="checkbox"/> 18" <input type="checkbox"/> 19" <input type="checkbox"/> 20" <input type="checkbox"/> 21"		
<input type="checkbox"/> 22" <input type="checkbox"/> 23" <input type="checkbox"/> 24" <input type="checkbox"/> 25"		
<b>Armrests:</b>		
<input type="checkbox"/> 2-Post, Fixed, Flip Back <sup>2</sup>	No Charge	
<input type="checkbox"/> Flip-Back, Cane Mounted <sup>2</sup>	\$95 ea.	
<input type="checkbox"/> Removable, Adjustable, Quick Height <sup>3</sup>	\$275 ea.	E0973
<input type="checkbox"/> Removable, Single-Post, Fixed Height Adjustable Heavy Duty	\$150 ea.	E0973
<input type="checkbox"/> 8-12" Adjustment <input type="checkbox"/> 10-14" Adjustment		

**SPECIALTY SEAT (cont.)**

Description	Price
<b>Armpads:</b>	
<input type="checkbox"/> Straight, Full Length (2"x14")	Standard
<input type="checkbox"/> Left <input type="checkbox"/> Right	
<input type="checkbox"/> Straight, Desk Length (2"x10")	No Charge
<input type="checkbox"/> Left <input type="checkbox"/> Right	
<input type="checkbox"/> Waterfall, Full Length (2"x14")	No Charge
<input type="checkbox"/> Left <input type="checkbox"/> Right	
<input type="checkbox"/> Waterfall, Desk Length (2"x10")	No Charge
<input type="checkbox"/> Left <input type="checkbox"/> Right	

**SYNERGY® SEATING SYSTEMS**

Description	Price	HCPCS Code
<input type="checkbox"/> Synergy Seating Frame	\$434	
<input type="checkbox"/> Standard Stem Mounts		
<input type="checkbox"/> 2" Extended Vertical Stem Mounts <sup>4</sup>		
<input type="checkbox"/> Synergy Manual Recline Package <sup>5</sup>	\$700	E1226
<input type="checkbox"/> Synergy Manual Tilt Package <sup>6</sup>	\$550	K0108
<i>Max. Seat Size 14"W x 14"D, 75 lbs Weight Capacity</i>		
<b>Seat Width:</b>		
<input type="checkbox"/> 10" <input type="checkbox"/> 11" <input type="checkbox"/> 12" <input type="checkbox"/> 13" <input type="checkbox"/> 14"		
<input type="checkbox"/> 15" <input type="checkbox"/> 16" <input type="checkbox"/> 17" <input type="checkbox"/> 18" <input type="checkbox"/> 19"		
<input type="checkbox"/> 20"		
<b>Seat Width Package:</b>		
<input type="checkbox"/> 10"W-14"W <input type="checkbox"/> 14"W-18"W <input type="checkbox"/> 16"W-20"W		
<b>Seat Depth:</b>		
<input type="checkbox"/> 10" <input type="checkbox"/> 11" <input type="checkbox"/> 12" <input type="checkbox"/> 13" <input type="checkbox"/> 14"		
<input type="checkbox"/> 15" <input type="checkbox"/> 16" <input type="checkbox"/> 17" <input type="checkbox"/> 18" <input type="checkbox"/> 19"		
<input type="checkbox"/> 20"		
<b>Seat Depth Package:</b>		
<input type="checkbox"/> 10"D-14"D <input type="checkbox"/> 14"D-18"D <input type="checkbox"/> 16"D-20"D		
<b>Back Cane Height:</b>		
<input type="checkbox"/> 14" <input type="checkbox"/> 15" <input type="checkbox"/> 16" <input type="checkbox"/> 17"		
<input type="checkbox"/> 18" <input type="checkbox"/> 19" <input type="checkbox"/> 20" <input type="checkbox"/> 21"		
<input type="checkbox"/> 22" <input type="checkbox"/> 23" <input type="checkbox"/> 24" <input type="checkbox"/> 25"		
<b>Back Rest Height:</b>		
<input type="checkbox"/> 18" <input type="checkbox"/> 19" <input type="checkbox"/> 20" <input type="checkbox"/> 21"		
<input type="checkbox"/> 22" <input type="checkbox"/> 23" <input type="checkbox"/> 24" <input type="checkbox"/> 25"		

**SYNERGY® BACK CANE OPTIONS**

Description	Price
<input type="checkbox"/> Standard Back Canes With Push Handles	Standard
<input type="checkbox"/> Omit Push Handles	\$125
<input type="checkbox"/> Flip Forward Canes <sup>7</sup>	\$150
<input type="checkbox"/> Omit Push Handles	\$125
<input type="checkbox"/> Offset (Meso) <sup>8</sup>	\$195
<input type="checkbox"/> 2" (1" Per Side) <input type="checkbox"/> 4" (2" Per Side)	
<input type="checkbox"/> Inset (Endo) <sup>8</sup>	\$195
<input type="checkbox"/> 2" (1" Per Side) <input type="checkbox"/> 4" (2" Per Side)	

**SYNERGY® BACK OPTIONS**

Description	Price	HCPCS Code
<input type="checkbox"/> Synergy Back with 1.5" Thick Back Cushion	\$275	
<i>Choose Lateral Extension:</i>		
<input type="checkbox"/> 10" (For Back Heights 18")	\$25	
<input type="checkbox"/> 12" (For Back Heights 19"-22")	\$25	
<input type="checkbox"/> 16" (For Back Heights 23"-25")	\$25	
<input type="checkbox"/> Synergy Shape Back Positioning Back	Various	E2613/E2614
<i>See Synergy Shape Back Order Form For Detailed Pricing, Sizes and Codes</i>		
<input type="checkbox"/> Sling Back	\$98	
<input type="checkbox"/> Omit Back	No Charge	

**FOOTNOTES**

- Includes black vinyl seat pan. Back available in listed colors.
- Swing-away laterals interfere with flip-back arms. Call for configuration with Shape Back.
- Adjustable from 11" to 17" in .5" increments.
- Lowest seat-to-floor height not available. Refer to chart on page 1.
- Not available with Flip Back Arms, Cantilever Arms, Shape Back or Power Elevate. Requires 22"H canes. Pivot point 2.5" above seat pan. In iQuantum this option should be chosen under 'Depth Package Type' and also 'Back Cane Type'.
- In i-Quantum this option is chosen under "Width Package Type".
- Not available with Synergy Manual Recline, Bariatric Armpads, Sling Back or Flip-up Cane Mounted Arms. May interfere with lateral supports and waterfall armpads. Tru Comfort requires SOF.
- Dual Post Flip-back Armrests interfere with Meso canes. Not available with Manual Recline.

**TRU-COMFORT™ SEATING**

**LATERALS**

Description	Price	HCPCS Code
<i>Please refer to TRU-Comfort Cushion and TRU-Comfort Back order forms for detailed pricing, sizes and codes.</i>		
<b>TRU-Comfort™ Back Cushion</b>		
<input type="checkbox"/> 16" W <input type="checkbox"/> 18" W <input type="checkbox"/> 20" W	\$595	E2620
<b>Back Height:¹</b>		
<input type="checkbox"/> 22" H <input type="checkbox"/> 25" H	No Charge	
<b>Cover:</b>		
<input type="checkbox"/> Standard <i>Allure leather-like cover</i>	No Charge	
<input type="checkbox"/> Plus <i>4-way stretch material cover</i>	No Charge	
<b>TRU-Comfort™ Seat Cushion</b> <i>General Use</i>		
<i>Includes Allure leather-like cover</i>		
<input type="checkbox"/> 16" x 16" - 20" x 18"	\$380	E2601
<input type="checkbox"/> 20" x 20" - 20" x 20"	\$380	E2601
<b>TRU-Comfort™ Plus Seat Cushion</b> <i>Skin Protection</i>		
<i>Includes 4-way stretch material cover</i>		
<input type="checkbox"/> 16" x 16" - 20" x 18"	\$380	E2603
<input type="checkbox"/> 20" x 20" - 20" x 20"	\$380	E2603

Description	Price	HCPCS Code
<input type="checkbox"/> <b>Stealth Thoracic Laterals (pair)</b>		
<i>Bracket:</i>		
<input type="checkbox"/> 125° Swing-Away Bracket¹¹	\$450	E1028
<i>(For Use with TRU-Comfort)</i>		
<input type="checkbox"/> Swing-Away, Rail Mount Bracket¹⁰	\$450	E1028
<i>(For Use with Synergy Back)</i>		
<i>Pad:</i>		
<input type="checkbox"/> Flat Pad, 3" x 5", Leather-Like Cover	\$200	E0956
<input type="checkbox"/> Flat Pad, 4" x 6", Leather-Like Cover	\$200	E0956
<input type="checkbox"/> Curved Pad, 2" x 3", 4-Way Stretch Cover	\$200	E0956
<input type="checkbox"/> Curved Pad, 3" x 5", 4-Way Stretch Cover	\$200	E0956
<input type="checkbox"/> Curved Pad, 4" x 6", 4-Way Stretch Cover	\$200	E0956
<input type="checkbox"/> <b>Stealth Pelvic/Thigh Laterals</b>		
<i>Side:</i>		
<input type="checkbox"/> Left Side <input type="checkbox"/> Right Side		
<i>Bracket:</i>		
<input type="checkbox"/> Removable Bracket (ea.)	\$250	E1028
<input type="checkbox"/> Removable Bracket w/ 1" Offset (ea.)	\$325	E1028
<input type="checkbox"/> Flip Down Bracket (ea.)	\$225	E1028
<i>Pad:</i>		
<input type="checkbox"/> Short Pad, 4" x 4" (ea.)	\$90	E0956
<input type="checkbox"/> Medium Pad, 4" x 8" (ea.)	\$90	E0956
<input type="checkbox"/> Long Pad, 4" x 12" (ea.)	\$90	E0956
<i>Adapter:</i>		
<input type="checkbox"/> 2" Depth/Height Adapter Plate¹¹	\$25	K0108

**ARMRESTS**

Description	Price	HCPCS Code
<input type="checkbox"/> Flip-back, Cane Mounted²	No Charge	
<input type="checkbox"/> 2-post, Flip-back, Height-adjustable, Removable²,³,⁴	\$150 ea.	E0973
<input type="checkbox"/> Single-post, Height-adjustable, Removable⁴,⁵	\$75 ea.	E0973
<input type="checkbox"/> Quad Release Lever		
<input type="checkbox"/> Bariatric, Removable Height, Adjustable⁶	\$75 ea.	E0973
<input type="checkbox"/> 8"H - 12"H <input type="checkbox"/> 10"H-14"H		
<input type="checkbox"/> Removable, Single-post, Height Adjustable, Heavy Duty	\$75 ea.	E0973
<input type="checkbox"/> 8"H - 12"H <input type="checkbox"/> 10"H-14"H		
<input type="checkbox"/> Pediatric, Removable⁷	\$75 ea.	E0973
<i>Color:</i> <input type="checkbox"/> Match Shroud <input type="checkbox"/> Black		
<input type="checkbox"/> Quad Release Lever		
<input type="checkbox"/> Height Adjustable Cantilever Armrests⁸	\$195	K0020
<i>Angle-Adjustable: - 30° through + 30°</i>		

**HEADRESTS**

Description	Price	HCPCS Code
<input type="checkbox"/> No Headrest Required		
<b>TRU-Comfort™ Headrest¹²</b>		
<input type="checkbox"/> 8" Wide Leatherette	\$205	E0955
<input type="checkbox"/> 8" TRU-Comfort Plus	\$205	E0955
<input type="checkbox"/> 10" Wide Leatherette	\$205	E0955
<input type="checkbox"/> 10" TRU-Comfort Plus	\$205	E0955
<input type="checkbox"/> Removable Headrest Bracket	\$210	E1028
<b>Stealth</b>		
<input type="checkbox"/> Small (9.75"W x 3"H)	\$205	E0955
<input type="checkbox"/> Large (11"W x 6"H)	\$205	E0955
<input type="checkbox"/> Pediatric Comfort Plus (6"W)	\$142	E0955
<input type="checkbox"/> Small Comfort Plus (10"W)	\$142	E0955
<input type="checkbox"/> Large Comfort Plus (14"W)	\$142	E0955
<input type="checkbox"/> Removable Headrest Bracket	\$210	E1028
<input type="checkbox"/> Swing-away (Flip-down) Headrest Bracket	\$210	E1028
<i>Used in Addition to Removable Headrest Bracket</i>		
<b>Aftermarket Bracket</b>		
<input type="checkbox"/> The World's Best Removable Headrest Hardware	\$210	E1028

**ARMPADS**

Description	Price
<input type="checkbox"/> Straight, Full Length (2"x14")	Standard
<input type="checkbox"/> Left <input type="checkbox"/> Right	
<input type="checkbox"/> Straight, Desk Length (2"x10")	No Charge
<input type="checkbox"/> Left <input type="checkbox"/> Right	
<input type="checkbox"/> Waterfall, Full Length (2"x14")⁹	No Charge
<input type="checkbox"/> Left <input type="checkbox"/> Right	
<input type="checkbox"/> Waterfall, Desk Length (2"x10")⁹	No Charge
<input type="checkbox"/> Left <input type="checkbox"/> Right	
<input type="checkbox"/> Falcon Gel, Full Length, (3.5"x14")	\$160 pr.
<input type="checkbox"/> Left <input type="checkbox"/> Right	
<input type="checkbox"/> Full Length Gel Armpad Mounting Plate (Required)	\$56.69 ea.
<input type="checkbox"/> Falcon Gel, Desk Length, (3.5"x10")	\$125 pr.
<input type="checkbox"/> Left <input type="checkbox"/> Right	
<input type="checkbox"/> Desk Length Gel Armpad Mounting Plate (Required).	\$53.52 ea.
<input type="checkbox"/> Flat, Bariatric⁶	No Charge
<input type="checkbox"/> Left <input type="checkbox"/> Right	

**LED LIGHTING PACKAGE**

Description	Price
<input type="checkbox"/> Through Remote Plus 7-Key	\$995

**FOOTNOTES**

1. TRU-Comfort Back Height is measured from the top of a 3" seat cushion.
2. Interferes with swing-away laterals.
3. Height adjustable from 9"-13" in 1" increments.
4. Not available with a depth less than 14".
5. Height adjustable from 11"-17" in 1/2" increments.
6. Bariatric Arms and Bariatric Armpads must be used together.
7. Height adjustable from 7.75"-9.75" in 1/2" increments. Not available with Full Length Armpads.
8. Height adjustment from 11"-17" depends on cane height. Not available with Manual Recline, Flip Forward back canes, Cane Clamp Pushbar, & Shape Back. Call for details when selecting aftermarket arm troughs or Universal Swivel.
9. Not available w/ Cane Mounted, Flip Back Armrests combined with a Synergy Back.
10. Swing-away laterals interfere with flip-up arms.
11. Height adapter plate is needed w/ Tru Comfort seat cushion. Not available on the flip down bracket.
12. TRU-Comfort™ Headrests are measured at the front of the pad.

**HIGH MOUNT FOOT PLATFORM**

Description	Price	HCPCS Code
<input type="checkbox"/> High Mount Foot Platform <sup>1</sup>	\$450	K0108
Extensions:		
<input type="checkbox"/> 10"-14" Ext. <sup>2</sup>		<input type="checkbox"/> 14"-17" Ext. <sup>2</sup>
Platform:		
<input type="checkbox"/> 9.5"D		<input type="checkbox"/> 11.62"D

**NON-POWERED LEGRESTS**

Description	Price	HCPCS Code
<input type="checkbox"/> <b>Swing-away Legrests<sup>2</sup></b>	Standard	
<input type="checkbox"/> 70° <input type="checkbox"/> 80°		
<input type="checkbox"/> Straight <input type="checkbox"/> Tapered (70° only)		
<input type="checkbox"/> Standard Extruded Footplates	No Charge	
Standard Extruded Extensions:		
<input type="checkbox"/> 11"-13"	<input type="checkbox"/> 13"-16.5"	<input type="checkbox"/> 15.5"-19.5"
<input type="checkbox"/> 18.5"-22.5"		
Standard Extruded Footplate Size:		
<input type="checkbox"/> 7.25" x 6"	<input type="checkbox"/> 8.5" x 6"	
<input type="checkbox"/> Angle-Adjustable Footplates <sup>3</sup>	\$150	K0040
Angle Adjustable Extensions:		
<input type="checkbox"/> 11"-13"	<input type="checkbox"/> 13"-16.5"	<input type="checkbox"/> 15.5"-19.5"
<input type="checkbox"/> 18.5"-22.5"		
Angle-Adjustable Footplate Size:		
<input type="checkbox"/> 4" x 6"	<input type="checkbox"/> 5" x 6"	<input type="checkbox"/> 5" x 8"
<input type="checkbox"/> 6" x 8" <sup>4</sup>	<input type="checkbox"/> 6" x 11" <sup>4</sup>	<input type="checkbox"/> 8" x 11" <sup>5</sup>
<input type="checkbox"/> Multi-Axis Footplates <sup>3</sup>	\$495	K0040
Multi-Axis Extensions:		
<input type="checkbox"/> 11"-16.5"	<input type="checkbox"/> 15.5"-19.5"	<input type="checkbox"/> 18.5"-22.5"
Multi-Axis Footplate Size:		
<input type="checkbox"/> 4" x 6"	<input type="checkbox"/> 5" x 6"	<input type="checkbox"/> 5" x 8"
<input type="checkbox"/> 6" x 8" <sup>4</sup>	<input type="checkbox"/> 6" x 11" <sup>4</sup>	<input type="checkbox"/> 8" x 11" <sup>5</sup>

<input type="checkbox"/> <b>High Mount, Clamp-On Footrest</b>		
<input type="checkbox"/> Angle Adjustable		
<input type="checkbox"/> Small, 4" x 7.75"	\$356	K0040
<input type="checkbox"/> Large, 4.25" x 9.25"	\$356	
<input type="checkbox"/> Multi-Axis		
<input type="checkbox"/> Small, 4" x 7.75"	\$456	K0040
<input type="checkbox"/> Large, 4.25" x 9.25"	\$460	

<input type="checkbox"/> <b>Heavy Duty Drop-In Legrests<sup>1,2</sup></b>	\$420	
<input type="checkbox"/> 70° <input type="checkbox"/> 80°		
<input type="checkbox"/> Angle Adjustable Footplates <sup>3</sup>	\$150	K0040
Angle Adjustable Extension Length:		
<input type="checkbox"/> 12"-14.5"	<input type="checkbox"/> 14.5" -18"	<input type="checkbox"/> 17.5"-21"
Angle Adjustable Footplate Size:		
<input type="checkbox"/> 4" x 6"	<input type="checkbox"/> 5" x 6"	<input type="checkbox"/> 5" x 8"
<input type="checkbox"/> 6" x 8" <sup>4</sup>	<input type="checkbox"/> 6" x 11" <sup>4</sup>	<input type="checkbox"/> 8" x 11" <sup>5</sup>

<input type="checkbox"/> <b>Elevating Legrests<sup>2</sup></b>	\$325	E0990
<input type="checkbox"/> Standard Footplates		
Standard Extruded Extension Length:		
<input type="checkbox"/> 11"-14"	<input type="checkbox"/> 14"-17"	<input type="checkbox"/> 17"-20"
Standard Extruded Footplate Size:		
<input type="checkbox"/> 7.25" x 6"	<input type="checkbox"/> 8.5" x 6"	
Calf Pad Adjustment		
<input type="checkbox"/> 1 Hole	<input type="checkbox"/> 3 Hole	<input type="checkbox"/> 6 Hole
<input type="checkbox"/> Angle Adjustable Footplates <sup>3</sup>	\$150	K0040
Angle Adjustable Extension Length:		
<input type="checkbox"/> 12"-14.5"	<input type="checkbox"/> 14.5" -18"	<input type="checkbox"/> 17.5"-21"
Angle Adjustable Footplate Size:		
<input type="checkbox"/> 4" x 6"	<input type="checkbox"/> 5" x 6"	<input type="checkbox"/> 5" x 8"
<input type="checkbox"/> 6" x 8" <sup>4</sup>	<input type="checkbox"/> 6" x 11" <sup>4</sup>	<input type="checkbox"/> 8" x 11" <sup>5</sup>
Calf Pad Adjustment		
<input type="checkbox"/> 1 Hole	<input type="checkbox"/> 3 Hole	<input type="checkbox"/> 6 Hole

<input type="checkbox"/> <b>90° Pediatric Swing-Away Legrests<sup>2,3</sup></b>	No Charge	
Angle Adjustable Extension Length:		
<input type="checkbox"/> 7"-10"		
Angle Adjustable Footplate Size:		
<input type="checkbox"/> 4" x 6"	<input type="checkbox"/> 5" x 6"	

**ELECTRONICS FOR POWER OPTIONS**

Description	Price	HCPCS Code
<input type="checkbox"/> Power Elevating Seat Through 6-Key VSI	N/C	
<input type="checkbox"/> Power Elevating Seat Through Remote Plus	\$1,175	
<input type="checkbox"/> Multiple Actuator Through Remote Plus	\$2,375	E2311

**POWER ELEVATING LEGRESTS**

Description	Price	HCPCS Code
<input type="checkbox"/> <b>Articulating Swing-Away Legrests, 4" Articulation Range<sup>1</sup></b>	\$2,395	E1010
<input type="checkbox"/> 70° <input type="checkbox"/> 80°		
<input type="checkbox"/> Quad Release Lever		
Calf Pads <sup>7</sup> :		
<input type="checkbox"/> 6" x 5.35"	<input type="checkbox"/> 8" x 5.86"	
Angle Adjustable Extension Length <sup>2</sup> :		
<input type="checkbox"/> 11"-13"	<input type="checkbox"/> 14.5"-18"	<input type="checkbox"/> 17.5"-21"
Angle Adjustable Footplate Size:		
<input type="checkbox"/> 4" x 6"	<input type="checkbox"/> 5" x 6"	<input type="checkbox"/> 5" x 8"
<input type="checkbox"/> 6" x 8" <sup>4</sup>	<input type="checkbox"/> 6" x 11" <sup>4</sup>	<input type="checkbox"/> 8" x 11" <sup>5</sup>
Operational Method:		
<input type="checkbox"/> Independent	<input type="checkbox"/> Combined	
<input type="checkbox"/> <b>Articulating Drop-In Legrests<sup>1</sup></b>	\$2,395	E1010
<input type="checkbox"/> 70° <input type="checkbox"/> 80°		
<input type="checkbox"/> 4" Range <input type="checkbox"/> 6" Range		
Calf Pads <sup>7</sup> :		
<input type="checkbox"/> 6" x 5.35"	<input type="checkbox"/> 8" x 5.86"	
Angle Adjustable Extension Length <sup>2</sup> :		
<input type="checkbox"/> 12"-14.5"	<input type="checkbox"/> 14.5"-18"	<input type="checkbox"/> 17.5"-21"
Angle Adjustable Footplate Size:		
<input type="checkbox"/> 4" x 6"	<input type="checkbox"/> 5" x 6"	<input type="checkbox"/> 5" x 8"
<input type="checkbox"/> 6" x 8" <sup>4</sup>	<input type="checkbox"/> 6" x 11" <sup>4</sup>	<input type="checkbox"/> 8" x 11" <sup>5</sup>
Operational Method:		
<input type="checkbox"/> Independent	<input type="checkbox"/> Combined	

**FOOT RIGGING ACCESSORIES**

Description	Price	HCPCS Code
<input type="checkbox"/> Wheel Bumpers <sup>9</sup>	\$25	
<input type="checkbox"/> Heel Loops (pair) <sup>10</sup>	\$38	E0951
<input type="checkbox"/> Gel Neoprene Footrest Sleeve (pair) <sup>11</sup>	\$65	K0108
<input type="checkbox"/> ELR/ALR Adductor Buttons (pair)	\$125	K0108
<input type="checkbox"/> POSAlinc Knee Adductor for Swing-Away Legrests (pair)	\$256	K0108
<input type="checkbox"/> POSAlinc Rail Mounted Knee Adductor (pair)	\$287	K0108
<input type="checkbox"/> Residual Limb Support	\$300	E1020
<input type="checkbox"/> Left <input type="checkbox"/> Right		
<input type="checkbox"/> Ankle Huggers (pair)	\$134	K0108
<input type="checkbox"/> Small <input type="checkbox"/> Medium		

**FOOTNOTES**

1. Available only on a Synergy Seat.
2. Extensions measured from top of seatpan to footplate.
3. Standard with Heel Loops.
4. Requires seat width 18" or greater.
5. Requires seat width 20".
6. Calf pads are selected in the Rigging Accessory section of i-Quantum.
7. Standard on Power Elevating Legrests.
8. Standard with angle adjustable footplates.
9. Available only with swing-away legrests.

**SYNERGY® CUSHIONS**

Description	Price	HCPCS Code
<input type="checkbox"/> No Cushion Required		
<i>Please refer to Synergy order forms for detailed pricing, sizes and codes.</i>		
<b>Simplicity Cushion</b> <i>General Use</i>		
<input type="checkbox"/> 16" x 16" - 20" x 20"	\$98	E2601
<b>Solution® 1 Cushion</b> <i>Skin Protection</i>		
<input type="checkbox"/> 14" x 14" - 20" x 18"	\$380	E2603
<input type="checkbox"/> 20" x 20" - 20" x 20"	\$430	E2603
<b>Solution® Cushion</b> <i>Skin Protection &amp; Positioning</i>		
<input type="checkbox"/> 10" x 10" - 20" x 18"	\$380	E2607
<input type="checkbox"/> 20" x 20" - 20" x 20"	\$430	E2607
<b>Spectrum® Gel Cushion</b> <i>Positioning</i>		
<input type="checkbox"/> 12" x 10" - 20" x 19"	\$480	E2605
<input type="checkbox"/> 20" x 20" - 20" x 20"	\$530	E2605
<b>Spectrum® Visco Cushion</b> <i>Skin Protection &amp; Positioning</i>		
<input type="checkbox"/> 10" x 10" - 20" x 18"	\$480	E2607
<input type="checkbox"/> 20" x 20" - 20" x 20"	\$530	E2607
<b>Spectrum Air®</b> <i>Adjustable Skin Protection</i>		
<input type="checkbox"/> 14" x 12" - 20" x 20"	\$480	E2622
<b>Spectrum Air Contour®</b> <i>Adjustable Skin Protection &amp; Positioning</i>		
<input type="checkbox"/> 14" x 12" - 20" x 20"	\$499	E2624

**MISCELLANEOUS POSITIONING COMPONENTS**

Description	Price	HCPCS Code
<input type="checkbox"/> Therafin Flip-down Knee Abductor Bracket <sup>1</sup>	\$172	E1028
<i>Pad:</i>		
<input type="checkbox"/> Small <input type="checkbox"/> Medium <input type="checkbox"/> Large	\$135	E0957
<input type="checkbox"/> Stealth Foot Boxes (pair)	\$475	K0108
<input type="checkbox"/> Small <input type="checkbox"/> Medium <input type="checkbox"/> Large		
<input type="checkbox"/> Stealth Padded Shoe Holders (pair)	\$166	K0108
<input type="checkbox"/> Small <input type="checkbox"/> Medium <input type="checkbox"/> X-Large		
<input type="checkbox"/> Otto Bock Arm Channels (ea.)	\$104	E2209
<i>Side:</i>		
<input type="checkbox"/> Left <input type="checkbox"/> Right		
<i>Size:</i>		
<input type="checkbox"/> Small <input type="checkbox"/> Medium <input type="checkbox"/> Large		
<input type="checkbox"/> Otto Bock Flat Hand Pad (ea.)	\$52	
<i>Side:</i>		
<input type="checkbox"/> Left <input type="checkbox"/> Right		
<i>Size:</i>		
<input type="checkbox"/> Medium <input type="checkbox"/> Large		

*Please see positioning components order form for additional types, sizes and details.*

**ACCESSORIES**

Description	Price	HCPCS Code
<input type="checkbox"/> Rear Basket <sup>2</sup>	\$103	
<input type="checkbox"/> Cane/Crutch Holder <sup>2</sup>	\$98	E2207
<input type="checkbox"/> Weather Cover, Medium, Black	\$158	
<input type="checkbox"/> Cup Holder	\$17	
<i>Side:</i>		
<input type="checkbox"/> Left <input type="checkbox"/> Right		
<input type="checkbox"/> Saddle Bag	\$28	
<input type="checkbox"/> Flag Holder	\$17	
<input type="checkbox"/> Quantum Backpack <sup>3</sup>	\$60	
<input type="checkbox"/> Oxygen Holder <i>Contoured Seating</i> <sup>2</sup>	\$103	E2208
<input type="checkbox"/> Oxygen Holder <i>Synergy Seat</i> <sup>4</sup>	\$150	E2208
<input type="checkbox"/> Walker Holder <sup>2</sup>	\$92	K0108
<input type="checkbox"/> Stroller Handle <i>Manual Tilt Only</i>	\$85	

**FOOTNOTES**

1. Not available with highmount footplatform.
2. Includes mounting hardware. Not available with Manual Recliner
3. Backpack may interfere w/ other rear accessories. Not available w/ contoured seating. Not available with Synergy manual recline, includes mounting hardware.
4. Not available with Synergy manual recline, includes mounting hardware.

**LAP BELTS**

Description	Price
<input type="checkbox"/> 38" Lap Belt <sup>2</sup>	Standard
<input type="checkbox"/> 50" Lap Belt <sup>2</sup>	Standard
<input type="checkbox"/> 60" Lap Belt	Standard
<input type="checkbox"/> 60" Non-Retractable (Sure-Lok)	
<input type="checkbox"/> 70" Lap Belt	Standard
<input type="checkbox"/> 80" Lap Belt	Standard
<input type="checkbox"/> 90" Lap Belt	Standard
<input type="checkbox"/> Pelvic Positioning Belt, 2-Point Padded Med, 9"-15" Hip Width	\$87
<input type="checkbox"/> Pelvic Positioning Belt, 2-Point Padded, Lg, 13"-19" Hip Width	\$92
<input type="checkbox"/> Pelvic Positioning Belt, 4-Point Padded, Med, 9"-15" Hip Width	\$112
<input type="checkbox"/> Pelvic Positioning Belt, 4-Point Padded, Lg, 13"-19" Hip Width	\$116

**BATTERY OPTIONS**

Description	Price	HCPCS Code
<input type="checkbox"/> NF-22, 50-Amp Batteries		
<input type="checkbox"/> Maintenance Free AGM	\$255 ea.	E2361
<input type="checkbox"/> Maintenance Free Gel Cell ( <i>Universal</i> )	\$295 ea.	E2361
<input type="checkbox"/> Maintenance Free Gel Cell ( <i>MK</i> )	\$295 ea.	E2361
<i>Installation:</i>		
<input type="checkbox"/> Batteries Installed		
<input type="checkbox"/> Do Not Install		

**Clinician Notes:**