

Quantum® 1420 Series

Group 3 Standard

Order Form

500 lbs. Weight Capacity

Weight Capacity May Be Limited By Configuration



Account Number: _____

Provider Name: _____

Contact: _____

Phone: _____

Fax: _____

Date: _____

PO#: _____

Marked For: _____

Ship To: _____

Address: _____

City: _____ State: _____ Zip: _____

Discount: _____

Terms: _____

Freight: _____

Taken By: _____

SET-TO-SPEC®

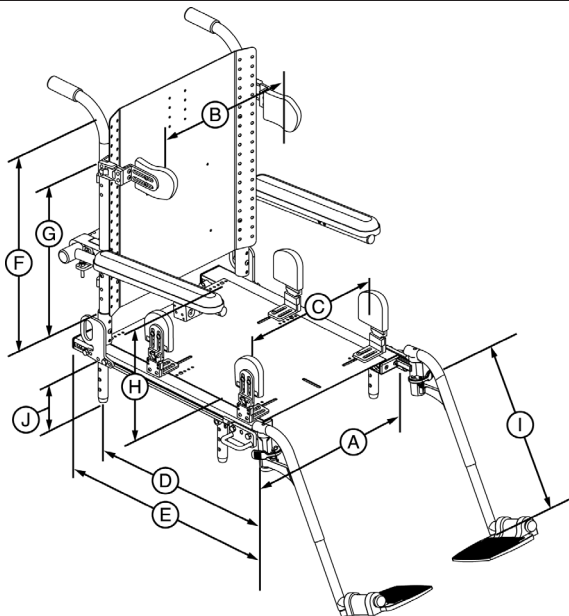

Please supply patient information for optimal setup prior to shipping.

Client Height: _____

Client Weight: _____

A. Seat Width: _____

B. Lateral Offset: _____

C. Hip/Thigh Lateral Offset: _____

D. Center of Gravity: *Optimized based on seat dimensions*

E. Seat Depth: _____

F. Back Height from Pan: _____

G. Lateral Height from Pan: _____

H. Armrest Height from Pan: _____

I. Rigging Length (whole numbers only): _____

J. Seat to Floor Height (circle one): _____

| Seating System | Low | Middle | Tall |
|-------------------|---------|---------|---------|
| Contoured Seating | 22.5" | 23.25" | 24" |
| Specialty Seat | 17.875" | 18.625" | 19.375" |
| Synergy® Seat | 18.125" | 19.125" | 20.125" |

Seat to floor height are +/- 1/8" with 18"W x 18"D with Flat-Free tires (add 3/8" for pneumatic tires). Increased widths may increase lowest seat to floor heights.

Clinician Notes: _____

* While every effort will be taken to ensure items will be preset to your specifications prior to shipping, variations in options may effect final settings.

DME providers are responsible for determining appropriate billing codes when submitting for insurance reimbursement.

HCPCS codes should not be considered as legal advice. All prices are MSRP.

BASE MODEL **EXPANDABLE CONTROLS**

| Description | Price | HCPCS Code |
|--|---------|------------|
| <input type="checkbox"/> Quantum 1420 3SPHD-C | \$9,113 | K0859 |
| <input type="checkbox"/> Quantum 1420 3SPHD-SS | \$9,113 | K0858 |
| <input type="checkbox"/> Quantum 1420 3SPVHD-C | \$9,113 | K0860 |

COLOR

| | |
|--|-------------------------------------|
| <input type="checkbox"/> Candy Apple Red | <input type="checkbox"/> Viper Blue |
| <input type="checkbox"/> Onyx Black | <input type="checkbox"/> Champagne |
| <input type="checkbox"/> Sunburst Orange | |

MOTOR OPTIONS

| Description | Price |
|--|----------|
| <input type="checkbox"/> High Torque Motor Package | Standard |
| <input type="checkbox"/> High Speed Motor Package ¹ | \$1,574 |

Programmable Speed Up To 6 MPH, 450 lbs. Weight Capacity. HS Motors decrease per-charge range.

BATTERY CHARGER

| Description | Price |
|---|----------|
| <input type="checkbox"/> 8 Amp, Off-board Charger | Standard |

DRIVE WHEELS

| Description | Price |
|--|-----------|
| <input type="checkbox"/> 16" Flat-Free | Standard |
| <input type="checkbox"/> 16" Pneumatic | No Charge |

CASTER WHEELS

| Description | Price |
|---------------------------------------|-----------|
| <input type="checkbox"/> 9" Flat-Free | Standard |
| <input type="checkbox"/> 9" Pneumatic | No Charge |



POWER ELEVATE

| Description | Price |
|--|-----------|
| <input type="checkbox"/> Power Elevating Seat | \$975 |
| <i>300 lbs. Weight Capacity, Maximum Seat Size 20"W x 20"D</i> | |
| <input type="checkbox"/> Through Toggle | |
| <input type="checkbox"/> Left Side <input type="checkbox"/> Right Side | |
| <input type="checkbox"/> Through VR2 6-Key | No Charge |
| <input type="checkbox"/> Through Q-Logic EX (Choose Electronics for Power Options on page 5) | |

BASE MOUNTED FOOT PLATFORM

| Description | Price |
|--|-----------|
| <input type="checkbox"/> No Base Mounted Front Platform | No Charge |
| <input type="checkbox"/> Base Mounted Foot Platform ² | Standard |



NON-EXPANDABLE CONTROLS

| Description | Price |
|---|-----------|
| <input type="checkbox"/> VR2 70 Amp 4-Key  | No Charge |
| <input type="checkbox"/> VR2 70 Amp 6-Key  | Standard |

FOOTNOTES

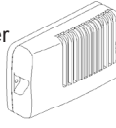
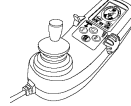
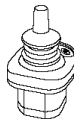

- Requires Q-Logic EX.
- Custom Footplatform sizes are available through the Quantum Applications and Development Dept.
- All mounting hardware is included in kit. See Specialty Electronics order form for additional mounting options and secondary controls. Bluetooth mouse emulator requires a run plug harness for either static or power seating. Additional fees will apply.
- Not available with Q-logic EX Stand Alone Joystick.
- Use HCPCS Code E2323 when not used in conjunction with a chin control.

Q-Logic EX Joystick or Enhanced Display must be ordered with a Q-Logic EX Controller and Harness For Expandable Controls

| Description | Price | HCPCS Code |
|--|------------|------------|
| <input type="checkbox"/> 100 Amp Q-Logic EX Controller  | \$695 | E2377 |
| <input type="checkbox"/> Harness For Expandable Controller | \$350 | E2313 |
| <input type="checkbox"/> Q-Logic EX Joystick  | \$700 | |
| <input type="checkbox"/> Q-Logic EX Standalone Joystick  | \$700 | E2373 |
| <input type="checkbox"/> Q-Logic EX Enhanced Display ³ w/ Bluetooth Mouse & IR Capability  | \$1,884.93 | |

(KITASMB1678)
Includes:
- Q-Logic EX Enhanced Display
- Flexible Gooseneck
- Enhanced Display Mounting Bracket

PROGRAMMING

| Description | Price |
|---|-------|
| <input type="checkbox"/> Q-Logic Handheld Programmer  | \$545 |
| <input type="checkbox"/> PG Handheld Programmer  | \$750 |
| <input type="checkbox"/> Q-Logic PC Programming Cable with Disk | \$750 |

JOYSTICK MOUNTING BRACKETS

| Description | Price | HCPCS Code |
|---|----------|------------|
| <input type="checkbox"/> Fixed Inline ⁴ | Standard | |
| <input type="checkbox"/> Left <input type="checkbox"/> Right | | |
| <input type="checkbox"/> Swing-away | \$210 | E1028 |
| <input type="checkbox"/> Left <input type="checkbox"/> Right | | |
| <input type="checkbox"/> Inline <input type="checkbox"/> Offset | | |
| <input type="checkbox"/> 4" Ext. <input type="checkbox"/> 7" Ext. | | |
| <input type="checkbox"/> Multi-axis Fixed | \$100 | K0108 |
| <input type="checkbox"/> Left <input type="checkbox"/> Right | | |

JOYSTICK HANDLES

| Description | Price | HCPCS Code |
|--|----------|--------------------|
| <input type="checkbox"/> Standard Knob | Standard | |
| <input type="checkbox"/> Mushroom Handle | \$71 | E2323 |
| <input type="checkbox"/> T-Bar | \$107 | E2323 |
| <input type="checkbox"/> Chin Cup | \$71 | E2324 ⁵ |
| <input type="checkbox"/> Extended I-Handle | \$71 | E2323 |
| <input type="checkbox"/> Soft Ball Handle | \$50 | E2323 |
| <input type="checkbox"/> Medium Ball Handle | \$50 | E2323 |
| <input type="checkbox"/> Bodypoint 3" Goal Post Handle | \$66 | E2323 |
| <input type="checkbox"/> Bodypoint 4" Goal Post Handle | \$66 | E2323 |

CONTOURED SEATING

Medium Back:
 Med-Back No Charge
 Med-Back with Solid Seat Pan¹ No Charge

Seat Width:
 16" 18"

Seat Depth:
 16" 18"

Upholstery:
 Brown Vinyl Beige Vinyl Gray Vinyl
 Black Vinyl Gray Fabric Brown Fabric

High Back:
 Limited Recline High-Back with Headrest No Charge
 Limited Recline High-Back with Headrest & Solid Seat Pan¹ No Charge

Seat Width²:
 16" 18" 20" 22" 24"

Seat Depth:
 16" 18" 20" 22" 24" 26"

Upholstery:
 Beige Vinyl Gray Vinyl Black Vinyl
 Gray Fabric Brown Fabric

Armrests:
 Flip-Up, Removable No Charge
 Flip-Up, Height-Adjustable, Removable \$170 E0973

Armrests:
 Left: Full Length Desk Length
 Right: Full Length Desk Length

MANUAL RECLINER

| Description | Price | HCPCS Code |
|--|-------|------------|
| <input type="checkbox"/> Manual Recliner High Back with Headrest | \$600 | E1226 |
| <input type="checkbox"/> Manual Recliner High Back with Headrest and Solid Seat Pan ¹ | \$600 | E1226 |

Upholstery:
 Beige Vinyl Gray Vinyl

Seat Width:
 16" 18" 20"

Seat Depth:
 16" 18" 20"

Armrests:
 Left: Full Length Desk Length
 Right: Full Length Desk Length

SPECIALTY SEAT

| Description | Price | HCPCS Code |
|---|-----------|------------|
| <input type="checkbox"/> Specialty Seat Kit | No Charge | |

Seat Width:
 16" 18" 20"

Seat Depth:
 16" 17" 18" 19"

Back Cane Height:
 18" 20" 22"

Back Rest Height:
 18" 19" 20" 21"
 22" 23" 24" 25"

Armrests:
 2-Post, Fixed, Flip Back³ No Charge
 Flip-Back, Cane Mounted³ \$95 ea.
 Removable, Adjustable, Quick Height⁴ \$275 ea. E0973
 Removable, Single-Post, Fixed Height Adjustable Heavy Duty \$150 ea. E0973
 8-12" Adjustment 10-14" Adjustment

SPECIALTY SEAT (Cont'd)

| Description | Price | HCPCS Code |
|--|-----------|------------|
| Armrests: | | |
| <input type="checkbox"/> Straight, Full Length (2"x14") | Standard | |
| <input type="checkbox"/> Left <input type="checkbox"/> Right | | |
| <input type="checkbox"/> Straight, Desk Length (2"x10") | No Charge | |
| <input type="checkbox"/> Left <input type="checkbox"/> Right | | |
| <input type="checkbox"/> Waterfall, Full Length (2"x14") | No Charge | |
| <input type="checkbox"/> Left <input type="checkbox"/> Right | | |
| <input type="checkbox"/> Waterfall, Desk Length (2"x10") | No Charge | |
| <input type="checkbox"/> Left <input type="checkbox"/> Right | | |

SYNERGY® SEATING SYSTEMS

| Description | Price | HCPCS Code |
|--|-------|------------|
| <input type="checkbox"/> Synergy Seating Frame | \$434 | |

Seat Width:
 10" 11" 12" 13" 14"
 15" 16" 17" 18" 19"
 20" 22" 24"

Seat Width Package:
 10"W-14"W 14"W-18"W 16"W-20"W 20"W-24"W

Seat Depth:
 10" 11" 12" 13" 14"
 15" 16" 17" 18" 19"
 20" 22" 24"

Seat Depth Package:
 10"D-14"D 14"D-18"D 16"D-20"D 20"D-24"D 24"D-28"D

Back Cane Height:
 14" 15" 16" 17"
 18" 19" 20" 21"
 22" 23" 24" 25"

Back Rest Height:
 18" 19" 20" 21"
 22" 23" 24" 25"

SYNERGY® BACK OPTIONS

| Description | Price | HCPCS Code |
|--|-----------|-------------|
| <input type="checkbox"/> Synergy Back with 1.5" Thick Back Cushion | \$275 | |
| <i>Choose Lateral Extension:</i> | | |
| <input type="checkbox"/> 10" (For Back Heights 18") | \$25 | |
| <input type="checkbox"/> 12" (For Back Heights 19"-22") | \$25 | |
| <input type="checkbox"/> 16" (For Back Heights 23"-25") | \$25 | |
| <input type="checkbox"/> Synergy Shape Back Positioning Back | Various | E2613/E2614 |
| <i>See Synergy Shape Back Order Form For Detailed Pricing, Sizes and Codes</i> | | |
| <input type="checkbox"/> Sling Back | \$98 | |
| <input type="checkbox"/> Heavy Duty Sling Back | \$150 | |
| <input type="checkbox"/> Omit Back | No Charge | |

SYNERGY® BACK CANE OPTIONS

| Description | Price | HCPCS Code |
|---|----------|------------|
| <input type="checkbox"/> Standard Back Canes | Standard | |
| <input type="checkbox"/> Omit Push Handles | \$125 | |
| <input type="checkbox"/> Offset (Meso) ⁵ | \$195 | |
| <input type="checkbox"/> 2" (1" Per Side) <input type="checkbox"/> 4" (2" Per Side) | | |
| <input type="checkbox"/> Inset (Endo) | \$195 | |
| <input type="checkbox"/> 2" (1" Per Side) <input type="checkbox"/> 4" (2" Per Side) | | |

FOOTNOTES

1. Includes black vinyl seatpan. Back available in listed colors.
2. Seats 22"W or wider can not be limited recline. Seat will have pinchless hinge.
3. Flip Back Armrests interfere with Swing Away Laterals.
4. Height adjustable from 11-17" in 1/2" Increments.
5. Dual Post Flip-back Armrests interfere with offset canes.

ARMRESTS

| Description | Price | HCPCS Code |
|--|-----------|------------|
| <input type="checkbox"/> Flip-back, Cane Mounted ¹ | No Charge | |
| <input type="checkbox"/> 2-post, Flip-back, Height-adjustable, Removable ^{1,2} | \$300 | E0973 |
| <input type="checkbox"/> Single-post, Height-adjustable, Removable ³ <input type="checkbox"/> Quad Release Lever | \$150 | E0973 |
| <input type="checkbox"/> Bariatric, Removable Height, Adjustable ⁴ <input type="checkbox"/> 8"H - 12"H <input type="checkbox"/> 10"H-14"H | \$150 | E0973 |
| <input type="checkbox"/> Removable, Single-post, Height Adjustable, Heavy Duty <input type="checkbox"/> 8"H - 12"H <input type="checkbox"/> 10"H-14"H | \$150 | E0973 |
| <input type="checkbox"/> Pediatric, Removable ⁵ Color: <input type="checkbox"/> Match Shroud <input type="checkbox"/> Black <input type="checkbox"/> Quad Release Lever | \$150 | E0973 |
| <input type="checkbox"/> Height Adjustable Cantilever Armrests ⁶ <i>Angle-Adjustable: - 30° through + 30°</i> | \$195 | K0020 |

ARMPADS

| Description | Price | HCPCS Code |
|--|-----------|------------|
| <input type="checkbox"/> Straight, Full Length (2"x14") <input type="checkbox"/> Left <input type="checkbox"/> Right | Standard | |
| <input type="checkbox"/> Straight, Desk Length (2"x10") <input type="checkbox"/> Left <input type="checkbox"/> Right | No Charge | |
| <input type="checkbox"/> Waterfall, Full Length (2"x14") <input type="checkbox"/> Left <input type="checkbox"/> Right | No Charge | |
| <input type="checkbox"/> Waterfall, Desk Length (2"x10") <input type="checkbox"/> Left <input type="checkbox"/> Right | No Charge | |
| <input type="checkbox"/> Falcon Gel, Full Length, (3.5"x14") <input type="checkbox"/> Left <input type="checkbox"/> Right | \$150 pr. | |
| <input type="checkbox"/> Falcon Gel, Desk Length, (3.5"x10") <input type="checkbox"/> Left <input type="checkbox"/> Right | \$115 pr. | |
| <input type="checkbox"/> Flat Bariatric ⁴ <input type="checkbox"/> Left <input type="checkbox"/> Right | No Charge | |

JOYSTICK MOUNTING BLOCKS

| Description | Price | HCPCS Code |
|---|-----------|------------|
| <input type="checkbox"/> Quick Disconnect ⁷ | No Charge | |
| <input type="checkbox"/> Vertical Adjustment Clamp | \$95 | K0108 |
| <input type="checkbox"/> Figure 8 style <i>(For use with waterfall armpads)</i> | No Charge | |

LAPBELTS

| Description | Price | HCPCS Code |
|--|----------|------------|
| <input type="checkbox"/> 38" Lap Belt ⁸ | Standard | |
| <input type="checkbox"/> 50" Lap Belt ⁸ | Standard | |
| <input type="checkbox"/> 60" Lap Belt | Standard | |
| <input type="checkbox"/> 70" Lap Belt | Standard | |
| <input type="checkbox"/> 80" Lap Belt | Standard | |
| <input type="checkbox"/> 90" Lap Belt | Standard | |
| <input type="checkbox"/> Pelvic Positioning Belt, 2-Point Padded, Lg, 13"-19" Hip Width | \$91 | |
| <input type="checkbox"/> Pelvic Positioning Belt, 4-Point Padded, Lg, 13"-19" Hip Width | \$116 | |

TRU-COMFORT™ SEATING

| Description | Price | HCPCS Code |
|---|-----------|------------|
| <i>Please refer to TRU-Comfort Cushion and TRU-Comfort Back order forms for detailed pricing, sizes and codes</i> | | |
| TRU-Comfort™ Back Cushion | | |
| <input type="checkbox"/> 16"W <input type="checkbox"/> 18" W <input type="checkbox"/> 20"W | \$595 | E2620 |
| <input type="checkbox"/> 22"W | \$695 | E2621 |
| Back Height:⁹ | | |
| <input type="checkbox"/> 22" H <input type="checkbox"/> 25" H | No Charge | |
| Cover: | | |
| <input type="checkbox"/> Standard <i>Allure leather-like cover</i> | No Charge | |
| <input type="checkbox"/> Plus <i>4-way stretch material cover</i> | No Charge | |
| TRU-Comfort™ Seat Cushion <i>General Use</i> <i>Includes Allure leather-like cover</i> | | |
| <input type="checkbox"/> 16" x 16" - 20" x 18" | \$380 | E2601 |
| <input type="checkbox"/> 20" x 20" - 20" x 20" | \$380 | E2601 |
| <input type="checkbox"/> 22" x 16" - 22" x 24" | \$480 | E2602 |
| TRU-Comfort™ Plus Seat Cushion <i>Skin Protection</i> <i>Includes 4-way stretch material cover</i> | | |
| <input type="checkbox"/> 16" x 16" - 20" x 18" | \$380 | E2603 |
| <input type="checkbox"/> 20" x 20" - 20" x 20" | \$380 | E2603 |
| <input type="checkbox"/> 22" x 16" - 22" x 24" | \$480 | E2604 |

VENT TRAY (SYNERGY SEAT ONLY)

| Description | Price | HCPCS Code |
|--|---------|------------|
| <input type="checkbox"/> Compact Vent Tray <i>The addition of a compact vent tray may increase the length & weight of your power chair.</i> | \$1,395 | |
| Mounting Bracket: Bracket is pre-selected with TRU-Comfort Back | | |
| <input type="checkbox"/> Flush <input type="checkbox"/> 3" Offset ¹⁰ <input type="checkbox"/> 6" Offset | | |
| <ul style="list-style-type: none"> - Accommodates Pulmonetics LTV-Style ventilators. - Max. Vent Size 3.25"H x 10.5"W x 13.5"D, 20 lbs max. - Not available with Power Elevating Seat, Flip Forward Canes, Shape Back, Sling Back, or rear mount accessories. | | |

LATERALS

| Description | Price | HCPCS Code |
|---|-------|------------|
| <input type="checkbox"/> Stealth Thoracic Laterals (pair) | | |
| <i>Bracket:</i> | | |
| <input type="checkbox"/> 125° Swing-Away Bracket ¹¹ <i>(For Use with TRU-Comfort)</i> | \$450 | E1028 |
| <input type="checkbox"/> Swing-Away, Rail Mount Bracket ¹¹ <i>(For Use with Synergy Back)</i> | \$450 | E1028 |
| <i>Pad:</i> | | |
| <input type="checkbox"/> Flat Pad, 3" x 5", Leather-Like Cover | \$200 | E0956 |
| <input type="checkbox"/> Flat Pad, 4" x 6", Leather-Like Cover | \$200 | E0956 |
| <input type="checkbox"/> Curved Pad, 2" x 3", 4-Way Stretch Cover | \$200 | E0956 |
| <input type="checkbox"/> Curved Pad, 3" x 5", 4-Way Stretch Cover | \$200 | E0956 |
| <input type="checkbox"/> Curved Pad, 4" x 6", 4-Way Stretch Cover | \$200 | E0956 |
| <input type="checkbox"/> Stealth Pelvic/Thigh Laterals | | |
| <i>Side:</i> | | |
| <input type="checkbox"/> Left Side <input type="checkbox"/> Right Side | | |
| <i>Bracket:</i> | | |
| <input type="checkbox"/> Removable Bracket (ea.) | \$250 | E1028 |
| <input type="checkbox"/> Flip Down Bracket (ea.) | \$225 | E1028 |
| <i>Pad:</i> | | |
| <input type="checkbox"/> Short Pad, 4" x 4" (ea.) | \$90 | E0956 |
| <input type="checkbox"/> Medium Pad, 4" x 8" (ea.) | \$90 | E0956 |
| <input type="checkbox"/> Long Pad, 4" x 12" (ea.) | \$90 | E0956 |

HEADRESTS

| Description | Price | HCPCS Code |
|---|-------|------------|
| <input type="checkbox"/> No Headrest Required | | |
| TRU-Comfort™ Headrest¹² | | |
| <input type="checkbox"/> 8"W Leatherette | \$205 | E0955 |
| <input type="checkbox"/> 8"W TRU-Comfort Plus | \$205 | E0955 |
| <input type="checkbox"/> 10"W Leatherette | \$205 | E0955 |
| <input type="checkbox"/> 10"W TRU-Comfort Plus | \$205 | E0955 |
| <input type="checkbox"/> Removable Headrest Bracket ¹³ | \$210 | E1028 |
| Stealth | | |
| <input type="checkbox"/> Small (9.75"W x 3"H) | \$205 | E0955 |
| <input type="checkbox"/> Large (11"W x 6"H) | \$205 | E0955 |
| <input type="checkbox"/> Pediatric Comfort Plus (6"W) | \$205 | E0955 |
| <input type="checkbox"/> Small Comfort Plus (10"W) | \$205 | E0955 |
| <input type="checkbox"/> Large Comfort Plus (14"W) | \$205 | E0955 |
| <input type="checkbox"/> Removable Headrest Bracket ¹³ | \$210 | E1028 |
| <input type="checkbox"/> Swing-away (Flip-down) Headrest Bracket | \$210 | E1028 |
| <i>Used in Addition to Removable Headrest Bracket</i> | | |
| Medical Applications | | |
| <input type="checkbox"/> Small (9.75"W x 3"H) | \$230 | E0955 |
| <input type="checkbox"/> Large (11"W x 6"H) | \$230 | E0955 |
| <input type="checkbox"/> Removable Headrest Bracket ¹³ | \$210 | E1028 |
| Aftermarket Bracket | | |
| <input type="checkbox"/> Removable Bracket for Aftermarket Headrest | \$210 | E1028 |

FOOTNOTES

1. Flip-Up Arms interfere with Swing-Away Laterals
2. Height adjustable from 9"-13" in 1" increments
3. Height adjustable from 11"-17" in 1/2" increments
4. Bariatric Arms and Bariatric Armpads must be used together
5. Height adjustable from 7.75"-9.75" in 1/2" increments. Requires Desk Length armpads.
6. Height adjustment from 11-17" depends on cane height. Not available with Flip Forward back canes, Cane Clamp Pushbar, & Shape Back. Call for details when selecting aftermarket arm troughs or Universal Swivel.
7. Not available with Waterfall Armpads.
8. Not available on Manual Recliner
9. Tru Comfort Back Height is measured from the top of a 3" cushion
10. Not available with Cane Mounted Flip-Up Arms.
11. Swing-away laterals interfere with flip-up arms.
12. TRU-Comfort headrest measurement is taken at the front of the pad.
13. When headrest pad is chosen i-Quantum automatically selects Removable Headrest Bracket.

MISCELLANEOUS POSITIONING COMPONENTS

| Description | Price | HCPCS Code |
|---|-------|------------|
| <input type="checkbox"/> Therafin Flip-down Knee Abductor Bracket ¹ | \$190 | E1028 |
| <i>Pad:</i> | | |
| <input type="checkbox"/> Small <input type="checkbox"/> Medium <input type="checkbox"/> Large | \$125 | E0957 |
| <input type="checkbox"/> Stealth Shoe Boxes (pair) | \$475 | K0108 |
| <input type="checkbox"/> Small <input type="checkbox"/> Medium <input type="checkbox"/> Large | | |
| <input type="checkbox"/> Stealth Padded Shoe Holders (pair) | \$166 | K0108 |
| <input type="checkbox"/> Small <input type="checkbox"/> Medium <input type="checkbox"/> X-Large | | |
| <input type="checkbox"/> Otto Back Arm Channels (ea.) | \$102 | E2209 |
| <i>Side:</i> | | |
| <input type="checkbox"/> Left <input type="checkbox"/> Right | | |
| <i>Size:</i> | | |
| <input type="checkbox"/> Small <input type="checkbox"/> Medium <input type="checkbox"/> Large | | |
| <input type="checkbox"/> Otto Back Flat Hand Pad (ea.) | \$51 | |
| <i>Side:</i> | | |
| <input type="checkbox"/> Left <input type="checkbox"/> Right | | |
| <i>Size:</i> | | |
| <input type="checkbox"/> Medium <input type="checkbox"/> Large | | |

Please see positioning components order form for additional types, sizes and details.

NON-POWERED LEGRESTS

| Description | Price | HCPCS Code |
|---|-----------|------------|
| <input type="checkbox"/> 70° Swing-away Legrests ² | \$162 | |
| <input type="checkbox"/> Straight <input type="checkbox"/> Tapered | | |
| <input type="checkbox"/> 70° <input type="checkbox"/> 80° (Straight Only) | | |
| <input type="checkbox"/> Standard Extruded Footplates | No Charge | |
| <i>Standard Extruded Extensions:</i> | | |
| <input type="checkbox"/> 11"-13" <input type="checkbox"/> 13"-16.5" <input type="checkbox"/> 15.5"-19.5" <input type="checkbox"/> 18.5"-22.5" | | |
| <i>Standard Extruded Footplates:</i> | | |
| <input type="checkbox"/> 7.25" x 6" <input type="checkbox"/> 8.5" x 6" | | |
| <input type="checkbox"/> Angle-Adjustable Footplates ³ | \$150 | K0040 |
| <i>Angle Adjustable Extensions:</i> | | |
| <input type="checkbox"/> 11"-13" <input type="checkbox"/> 13"-16.5" <input type="checkbox"/> 15.5"-19.5" <input type="checkbox"/> 18.5"-22.5" | | |
| <i>Angle-Adjustable Footplates:</i> | | |
| <input type="checkbox"/> 4" x 6" <input type="checkbox"/> 5" x 6" <input type="checkbox"/> 5" x 8" | | |
| <input type="checkbox"/> 6" x 8" ⁴ <input type="checkbox"/> 6" x 11" ⁴ <input type="checkbox"/> 8" x 11" ⁵ | | |
| <input type="checkbox"/> Multi-Axis Footplates ³ | \$495 | K0040 |
| <i>Multi-Axis Extensions:</i> | | |
| <input type="checkbox"/> 11"-16.5" <input type="checkbox"/> 15.5"-19.5" <input type="checkbox"/> 18.5"-22.5" | | |
| <i>Multi-Axis Footplates:</i> | | |
| <input type="checkbox"/> 4" x 6" <input type="checkbox"/> 5" x 6" <input type="checkbox"/> 5" x 8" | | |
| <input type="checkbox"/> 6" x 8" ⁴ <input type="checkbox"/> 6" x 11" ⁴ <input type="checkbox"/> 8" x 11" ⁵ | | |
| <input type="checkbox"/> High Mount, Clamp-On Footrest | | |
| <input type="checkbox"/> Angle Adjustable | \$326 | K0040 |
| <input type="checkbox"/> Small, 4" x 7.75" <input type="checkbox"/> Large, 4.25" x 9.25" | | |
| <input type="checkbox"/> Multi-Axis | \$412 | K0040 |
| <input type="checkbox"/> Small, 4" x 7.75" <input type="checkbox"/> Large, 4.25" x 9.25" | | |
| <input type="checkbox"/> Heavy Duty Drop-In Legrests ^{2,6} | \$420 | |
| <input type="checkbox"/> 70° <input type="checkbox"/> 80° | | |
| <input type="checkbox"/> Angle Adjustable Footplates ³ | \$150 | K0040 |
| <i>Angle Adjustable Extension Length:</i> | | |
| <input type="checkbox"/> 12"-14.5" <input type="checkbox"/> 14.5" -18" <input type="checkbox"/> 17.5"-21" | | |
| <i>Angle Adjustable Footplate Size:</i> | | |
| <input type="checkbox"/> 4" x 6" <input type="checkbox"/> 5" x 6" <input type="checkbox"/> 5" x 8" | | |
| <input type="checkbox"/> 6" x 8" ⁴ <input type="checkbox"/> 6" x 11" ⁴ <input type="checkbox"/> 8" x 11" ⁵ | | |
| <input type="checkbox"/> Elevating Legrests ² | \$325 | E0990 |
| <input type="checkbox"/> Standard Footplates | | |
| <i>Standard Extruded Extension Length:</i> | | |
| <input type="checkbox"/> 11"-14" <input type="checkbox"/> 14"-17" <input type="checkbox"/> 17"-20" | | |
| <i>Standard Extruded Footplate Size:</i> | | |
| <input type="checkbox"/> 7.25" x 6" <input type="checkbox"/> 8.5" x 6" | | |
| <i>Calf Pad Adjustment:</i> | | |
| <input type="checkbox"/> 1 Hole <input type="checkbox"/> 3 Hole <input type="checkbox"/> 6 Hole | | |
| <input type="checkbox"/> Angle Adjustable Footplates ³ | \$150 | K0040 |
| <i>Angle Adjustable Extension Length:</i> | | |
| <input type="checkbox"/> 12"-14.5" <input type="checkbox"/> 14.5"-18" <input type="checkbox"/> 17.5"-21" | | |
| <i>Angle Adjustable Footplate Size:</i> | | |
| <input type="checkbox"/> 4" x 6" <input type="checkbox"/> 5" x 6" <input type="checkbox"/> 5" x 8" | | |
| <input type="checkbox"/> 6" x 8" ⁴ <input type="checkbox"/> 6" x 11" ⁴ <input type="checkbox"/> 8" x 11" ⁵ | | |
| <i>Calf Pad Adjustment:</i> | | |
| <input type="checkbox"/> 1 Hole <input type="checkbox"/> 3 Hole <input type="checkbox"/> 6 Hole | | |

ELECTRONICS FOR POWER OPTIONS

| Description | Price | HCPCS Code |
|---|---------|------------|
| <i>This Option Is Automatically Selected In I-Quantum</i> | | |
| <input type="checkbox"/> Single Actuator Through Q-Logic EX | \$1,175 | |
| (PES Only) | | |
| <input type="checkbox"/> Multiple Actuator Through Q-Logic EX | \$2,375 | E2311 |

POWER ELEVATING LEGRESTS

| Description | Price | HCPCS Code |
|---|---------|------------|
| <i>Power Elevating Legrests Have A Maximum User Weight Capacity of 300lbs.</i> | | |
| <input type="checkbox"/> 70° Articulating Swing-Away Legrests, 4" Articulation Range ^{6,7} | \$2,395 | E1010 |
| <input type="checkbox"/> Quad Release Lever | | |
| <i>Calf Pads:</i> | | |
| <input type="checkbox"/> 6" x 5.35" <input type="checkbox"/> 8" x 5.86" | | |
| <i>Angle Adjustable Extension Length²:</i> | | |
| <input type="checkbox"/> 11"-13" <input type="checkbox"/> 14.5"-18" <input type="checkbox"/> 17.5"-21" | | |
| <i>Angle Adjustable Footplate Size:</i> | | |
| <input type="checkbox"/> 4" x 6" <input type="checkbox"/> 5" x 6" <input type="checkbox"/> 5" x 8" | | |
| <input type="checkbox"/> 6" x 8" ⁴ <input type="checkbox"/> 6" x 11" ⁴ <input type="checkbox"/> 8" x 11" ⁵ | | |
| <i>Operational Method:</i> | | |
| <input type="checkbox"/> Independent <input type="checkbox"/> Combined | | |

| Description | Price | HCPCS Code |
|---|---------|------------|
| <input type="checkbox"/> 70° Articulating Drop-In Legrests ^{6,7} | \$2,395 | E1010 |
| <i>Angle:</i> | | |
| <input type="checkbox"/> 70° <input type="checkbox"/> 80° | | |
| <i>Range:</i> | | |
| <input type="checkbox"/> 4" Range <input type="checkbox"/> 6" Range | | |
| <i>Calf Pads:</i> | | |
| <input type="checkbox"/> 6" x 5.35" <input type="checkbox"/> 8" x 5.86" | | |
| <i>Angle Adjustable Extension Length²:</i> | | |
| <input type="checkbox"/> 12"-14.5" <input type="checkbox"/> 14.5"-18" <input type="checkbox"/> 17.5"-21" | | |
| <i>Angle Adjustable Footplate Size:</i> | | |
| <input type="checkbox"/> 4" x 6" <input type="checkbox"/> 5" x 6" <input type="checkbox"/> 5" x 8" | | |
| <input type="checkbox"/> 6" x 8" ⁴ <input type="checkbox"/> 6" x 11" ⁴ <input type="checkbox"/> 8" x 11" ⁵ | | |
| <i>Operational Method:</i> | | |
| <input type="checkbox"/> Independent <input type="checkbox"/> Combined | | |

HIGHMOUNT FOOT PLATFORM

| Description | Price | HCPCS Code |
|---|-------|------------|
| <input type="checkbox"/> High Mount Foot Platform ⁶ | \$450 | K0108 |
| <i>Lower Extension Length:</i> | | |
| <input type="checkbox"/> 10"-14" Ext. ² <input type="checkbox"/> 14"-17" Ext. ² | | |
| <i>Foot Platform Size:</i> | | |
| <input type="checkbox"/> 9.55"D <input type="checkbox"/> 11.62"D | | |

FOOT RIGGING ACCESSORIES

| Description | Price | HCPCS Code |
|--|-------|------------|
| <input type="checkbox"/> Wheel Bumpers ⁸ | \$25 | |
| <input type="checkbox"/> Heel Loops (pair) ^{8,9} | \$38 | E0951 |
| <input type="checkbox"/> Gel Neoprene Footrest Sleeve (pair) ¹⁰ | \$65 | K0108 |
| <input type="checkbox"/> ELR/ALR Adductor Buttons (pair) | \$100 | K0108 |
| <input type="checkbox"/> POSAlinc Knee Adductor for Swing-Away Legrests (pair) | \$464 | K0108 |
| <input type="checkbox"/> POSAlinc Rail Mounted Knee Adductor (pair) | \$464 | K0108 |
| <input type="checkbox"/> Residual Limb Support | \$300 | E1020 |
| <input type="checkbox"/> Left <input type="checkbox"/> Right | | |
| <input type="checkbox"/> Ankle Huggers (pair) | \$126 | K0108 |
| <input type="checkbox"/> Small <input type="checkbox"/> Medium | | |

FOOTNOTES

- Not available with Highmount foot platform.
- Extension length is measured from the top of the seatpan to the footplate.
- Includes Heel Loops.
- Only available on seats wider than 18".
- Only available on seats wider than 20".
- Only available on Synergy Seat.
- Custom Footplatform sizes are available through the Quantum Applications and Development Dept.
- Power ALR's come standard with Angle Adjustable Footplates with Heel Loops and Wheel Bumpers.
- Standard with Angle Adjustable and Multi-Axis Footplates.
- Only available with Swing-Away Legrests.

SYNERGY® CUSHIONS

| <i>Description</i> | <i>Price</i> | <i>HCPCS Code</i> |
|---|--------------|-------------------|
| <input type="checkbox"/> No Cushion Required | | |
| <i>Please refer to Synergy order forms for detailed pricing, sizes and codes.</i> | | |
| Simplicity Cushion <i>General Use</i> | | |
| <input type="checkbox"/> 16" x 16" - 20" x 20" | \$98 | E2601 |
| <input type="checkbox"/> 22" x 16" - 24" x 24" | \$98 | E2602 |
| Solution® 1 Cushion <i>Skin Protection</i> | | |
| <input type="checkbox"/> 14" x 14" - 20" x 18" | \$380 | E2603 |
| <input type="checkbox"/> 20" x 20" - 20" x 24" | \$430 | E2603 |
| <input type="checkbox"/> 22" x 16" - 24" x 24" | \$430 | E2604 |
| Solution® Cushion <i>Skin Protection & Positioning</i> | | |
| <input type="checkbox"/> 10" x 10" - 20" x 18" | \$380 | E2607 |
| <input type="checkbox"/> 20" x 20" - 20" x 24" | \$430 | E2607 |
| <input type="checkbox"/> 22" x 16" - 24" x 24" | \$430 | E2608 |
| Spectrum® Gel Cushion <i>Positioning</i> | | |
| <input type="checkbox"/> 12" x 10" - 20" x 19" | \$480 | E2605 |
| <input type="checkbox"/> 20" x 20" - 20" x 24" | \$530 | E2605 |
| <input type="checkbox"/> 22" x 16" - 24" x 24" | \$530 | E2606 |
| Spectrum® Visco Cushion <i>Skin Protection & Positioning</i> | | |
| <input type="checkbox"/> 10" x 10" - 20" x 18" | \$480 | E2607 |
| <input type="checkbox"/> 20" x 20" - 20" x 24" | \$530 | E2607 |
| <input type="checkbox"/> 22" x 16" - 24" x 24" | \$530 | E2608 |
| Spectrum® Air <i>Adjustable Skin Protection</i> | | |
| <input type="checkbox"/> 14" x 12" - 20" x 24" | \$480 | E2622 |
| <input type="checkbox"/> 22" x 16" - 24" x 24" | \$530 | E2623 |
| Spectrum® Air Contour <i>Adjustable Skin Protection & Positioning</i> | | |
| <input type="checkbox"/> 14" x 12" - 20" x 24" | \$499 | E2624 |
| <input type="checkbox"/> 22" x 16" - 24" x 24" | \$549 | E2625 |

ACCESSORIES

| <i>Description</i> | <i>Price</i> | <i>HCPCS Code</i> |
|--|--------------|-------------------|
| <input type="checkbox"/> Rear Basket ¹ | \$103 | |
| <input type="checkbox"/> Cane/Crutch Holder ¹ | \$98 | E2207 |
| <input type="checkbox"/> Weather Cover, Medium, Black | \$158 | |
| <input type="checkbox"/> Cup Holder | \$17 | |
| <i>Side:</i> | | |
| <input type="checkbox"/> Left <input type="checkbox"/> Right | | |
| <input type="checkbox"/> Saddle Bag | \$28 | |
| <input type="checkbox"/> Flag Holder | \$17 | |
| <input type="checkbox"/> Quantum Backpack ² | \$60 | |
| <input type="checkbox"/> Oxygen Holder <i>Contoured Seating</i> ¹ | \$103 | E2208 |
| <input type="checkbox"/> Oxygen Holder <i>Synergy Seat</i> ³ | \$150 | E2208 |
| <input type="checkbox"/> Walker Holder ¹ | \$92 | K0108 |
| <input type="checkbox"/> Stroller Handle <i>Manual Tilt Only</i> | \$85 | |

BATTERY OPTIONS

| <i>Description</i> | <i>Price</i> | <i>HCPCS Code</i> |
|--|--------------|-------------------|
| <input type="checkbox"/> Group 24, 70 Amp, Gel (<i>Universal</i>) | \$352 ea. | E2363 |
| <input type="checkbox"/> Group 24, 70 Amp, Gel (<i>MK</i>) | \$352 ea. | E2363 |
| <input type="checkbox"/> NF-22, 50-Amp Batteries | | |
| <input type="checkbox"/> Maintenance Free AGM | \$255 ea. | E2361 |
| <input type="checkbox"/> Maintenance Free Gel Cell (<i>Universal</i>) | \$295 ea. | E2361 |
| <input type="checkbox"/> Maintenance Free Gel Cell (<i>MK</i>) | \$295 ea. | E2361 |
| <i>Installation:</i> | | |
| <input type="checkbox"/> Batteries Installed <input type="checkbox"/> Do Not Install | | |

FOOTNOTES

1. Includes mounting hardware. Not available with Manual Recliner
2. Backpack may interfere w/ other rear accessories. Not available w/ contoured seating.
3. Not available with Synergy manual recline, includes mounting hardware.