

Quantum® 6000Z HD Series
Group 3 Heavy Duty
Single Power & Multiple Power Order Form
450 lbs. weight capacity



Account Number: _____
 Provider Name: _____
 Contact: _____
 Phone: _____
 Fax: _____

Date: _____
 PO#: _____
 Marked For: _____

Ship To: _____
 Address: _____
 City: _____ State: _____ Zip: _____

Discount: _____
 Terms: _____
 Freight: _____
 Taken By: _____

SET-TO-SPEC®

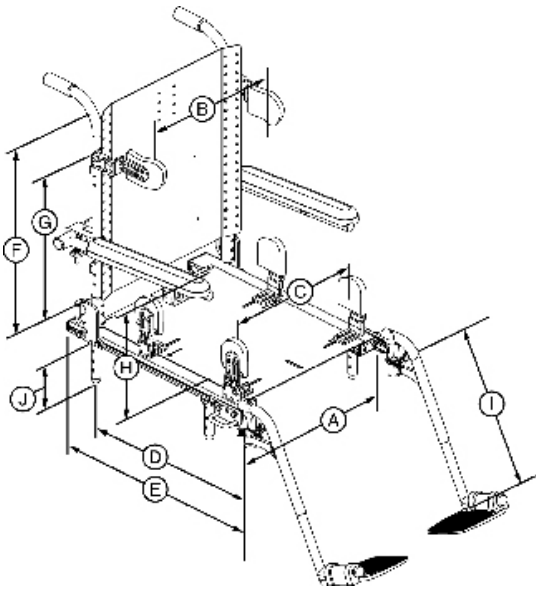

Please supply patient information for optimal setup prior to shipping.

Client Height: _____
 Client Weight: _____

- A. Seat Width: _____
- B. Lateral Offset: _____
- C. Hip/Thigh Lateral Offset: _____
- D. Center of Gravity: *Optimized based on seat dimensions*
- E. Seat Depth: _____
- F. Back Height from Pan: _____
- G. Lateral Height from Pan: _____
- H. Armrest Height from Pan: _____
- I. Rigging Length (whole numbers only): _____
- J. Seat to Floor Height (circle one): _____

Seat	Seat-To-Floor Heights			
TRU-Balance® Bariatric Tilt (Fixed Towers)	18.375"	19.25"	20.125"	21"
TRU-Balance® Bariatric Tilt (Angle Adjustable Towers)	19"	19.875"	20.75"	21.625"
TRU-Balance® Bariatric Tilt (Super Low)	18"	18.5"	19"	19.5"

Seat to floor height are +/- 1/8" with 24"W x 24"D with Flat-Free tires (add 3/8" for pneumatic tires). Increased widths may increase lowest seat to floor heights.

Clinician Notes: _____

** While every effort will be taken to ensure items will be preset to your specifications prior to shipping, variations in options may effect final settings.*

DME providers are responsible for determining appropriate billing codes when submitting for insurance reimbursement.

HCPCS codes should not be considered as legal advice. All prices are MSRP.

BASE MODEL	PROGRAMMING
<i>Description</i>	<i>Description</i>

<input type="checkbox"/> Quantum 6000Z HD 3SPHD-SS	\$7,560	K0858
<input type="checkbox"/> Quantum 6000Z HD 3MPHD-SS	\$7,360	K0862

Contact your Quantum Specialist for Multiple Power Options

<input type="checkbox"/> Q-Logic Handheld Programmer	\$545	
<input type="checkbox"/> Q-Logic PC Programming Cable with Disk	\$750	



COLOR	
<input type="checkbox"/> Metallic Red	<input type="checkbox"/> Metallic Blue
<input type="checkbox"/> Metallic Black	<input type="checkbox"/> Metallic Silver
<input type="checkbox"/> Metallic Orange	

DRIVE WHEELS	
<i>Description</i>	<i>Price</i>
<input type="checkbox"/> 14" Flat-Free	Standard
<i>Rim Color:</i>	<input type="checkbox"/> Black <input type="checkbox"/> Silver
<input type="checkbox"/> 4" Wide Flat Free, Knobby, Extended-Traction Tires ¹ (Available Thru SOF)	\$551

JOYSTICK HANDLES		
<i>Description</i>	<i>Price</i>	<i>HCPCS Code</i>
<input type="checkbox"/> Standard Knob	Standard	
<input type="checkbox"/> Mushroom Handle	\$71	E2323
<input type="checkbox"/> T-Bar	\$107	E2323
<input type="checkbox"/> Chin Cup	\$71	E2324 ³
<input type="checkbox"/> Extended I-Handle	\$71	E2323
<input type="checkbox"/> Soft Ball Handle	\$50	E2323
<input type="checkbox"/> Medium Ball Handle	\$50	E2323
<input type="checkbox"/> Bodypoint 3" Goal Post Handle	\$66	E2323
<input type="checkbox"/> Bodypoint 4" Goal Post Handle	\$66	E2323



BASE MOUNTED FOOT PLATFORM	
<i>Description</i>	<i>Price</i>
<input type="checkbox"/> No Base Mounted Front Platform	No Charge
<input type="checkbox"/> Base Mounted Foot Platform	Standard

JOYSTICK MOUNTING BRACKETS		
<i>Description</i>	<i>Price</i>	<i>HCPCS Code</i>

<input type="checkbox"/> Fixed Inline ⁴	Standard	
<input type="checkbox"/> Left <input type="checkbox"/> Right		
<input type="checkbox"/> Swing-away	\$210	E1028
<input type="checkbox"/> Left <input type="checkbox"/> Right		
<input type="checkbox"/> Inline <input type="checkbox"/> Offset		
<input type="checkbox"/> 4" Ext. <input type="checkbox"/> 7" Ext.		
<input type="checkbox"/> Multi-axis Fixed	\$100	K0108
<input type="checkbox"/> Left <input type="checkbox"/> Right		

BATTERY CHARGER	
<i>Description</i>	<i>Price</i>
<input type="checkbox"/> 8 Amp, Off-board Charger	Standard

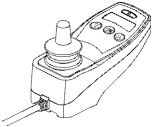
NON-EXPANDABLE CONTROLS	
<i>Description</i>	<i>Price</i>



<input type="checkbox"/> 75 Amp NE	Standard
	
<input type="checkbox"/> 75 Amp NE+ 6-Key For Up To 2 Actuators Thru Joystick	\$200
	
	Standard on 3SPHD-SS Package

SEATING SYSTEM		
<i>Description</i>	<i>Price</i>	<i>HCPCS Code</i>

<input type="checkbox"/> TRU-Balance® HD Power Tilt	\$7,250	K0108
<i>40 Degrees CG Tilt with Full Drive Lock-out Set at 20 Degrees</i>		
<input type="checkbox"/> Super Low Option ⁵	No Charge	

EXPANDABLE CONTROLS		
----------------------------	--	--

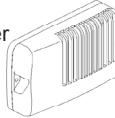
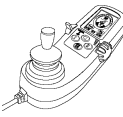
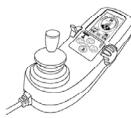
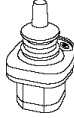
Q-Logic EX Joystick or Enhanced Display must be ordered with a Q-Logic EX Controller and Harness For Expandable Controls

<i>Description</i>	<i>Price</i>	<i>HCPCS Code</i>
<input type="checkbox"/> 100 Amp Q-Logic EX Controller	\$695	E2377
<input type="checkbox"/> Harness For Expandable Controller	\$350	E2313
		
<input type="checkbox"/> Q-Logic EX Joystick	\$700	
		
<input type="checkbox"/> Q-Logic EX Joystick for Lights	\$700	
Required For LED Light Package		
		
<input type="checkbox"/> Q-Logic EX Standalone Joystick	\$700	E2373
		
<input type="checkbox"/> Q-Logic EX Enhanced Display ²	\$1,884.93	
<i>w/ Bluetooth Mouse & IR Capability (KITASMB1678)</i>		
Includes:		
- Q-Logic EX Enhanced Display		
- Flexible Gooseneck		
- Enhanced Display Mounting Bracket		
		

SEATING SPECIFICATIONS				
-------------------------------	--	--	--	--

Tower Selection:				
<input type="checkbox"/> Angle Adjustable	<input type="checkbox"/> Super Low	<input type="checkbox"/> Fixed		
Seat Width:				
<input type="checkbox"/> 20"	<input type="checkbox"/> 21"	<input type="checkbox"/> 22"	<input type="checkbox"/> 23"	<input type="checkbox"/> 24"
<input type="checkbox"/> 25"	<input type="checkbox"/> 26"	<input type="checkbox"/> 27"	<input type="checkbox"/> 28"	
Seat Width Package:				
<input type="checkbox"/> 20"W-24"W	<input type="checkbox"/> 24"W-28"W			
Seat Depth:				
<input type="checkbox"/> 15"	<input type="checkbox"/> 16"	<input type="checkbox"/> 17"	<input type="checkbox"/> 18"	<input type="checkbox"/> 19"
<input type="checkbox"/> 20"	<input type="checkbox"/> 22"	<input type="checkbox"/> 23"	<input type="checkbox"/> 24"	<input type="checkbox"/> 25"
<input type="checkbox"/> 26"	<input type="checkbox"/> 27"	<input type="checkbox"/> 28"		
Seat Depth Package:				
<input type="checkbox"/> 15"D-20"D	<input type="checkbox"/> 20"D-24"D	<input type="checkbox"/> 24"D-28"D		
Back Cane Height:				
<input type="checkbox"/> 14"	<input type="checkbox"/> 15"	<input type="checkbox"/> 16"	<input type="checkbox"/> 17"	<input type="checkbox"/> 18"
<input type="checkbox"/> 19"	<input type="checkbox"/> 20"	<input type="checkbox"/> 21"	<input type="checkbox"/> 22"	<input type="checkbox"/> 23"
<input type="checkbox"/> 24"	<input type="checkbox"/> 25"			
Back Rest Height:				
<input type="checkbox"/> 18"	<input type="checkbox"/> 19"	<input type="checkbox"/> 20"	<input type="checkbox"/> 21"	<input type="checkbox"/> 22"
<input type="checkbox"/> 23"	<input type="checkbox"/> 24"	<input type="checkbox"/> 25"		

FOOTNOTES

1. Increases overall base width by 1.5".
2. All mounting hardware is included in kit. See Specialty Electronics order form for additional mounting options and secondary controls. Bluetooth mouse emulator requires a run plug harness for either static or power seating. Additional fees will apply.
3. Use code E2323 when not used in conjunction with a chin control.
4. Not available with Q-logic EX Stand Alone Joystick.
5. Requires Group 34 batteries.

BACK CANES

Description	Price	HCPCS Code
<input type="checkbox"/> Standard Back Canes With Push Handles	Standard	
<input type="checkbox"/> Standard Back Canes, No Push Handles	\$125	
<input type="checkbox"/> Offset (Meso)	\$195	
<input type="checkbox"/> 2" (1" Per Side)		<input type="checkbox"/> 4" (2" Per Side)
<input type="checkbox"/> Inset (Endo)	\$195	
<input type="checkbox"/> 2" (1" Per Side)		<input type="checkbox"/> 4" (2" Per Side)

BACK OPTIONS

Description	Price	HCPCS Code
Tilt Back:		
<input type="checkbox"/> Synergy Back with 1.5" thick back cushion		
<input type="checkbox"/> 20"W - 24"W	Standard	
<input type="checkbox"/> 25"W - 28"W	\$315	
Choose Lateral Extension:		
<input type="checkbox"/> 10" (For Back Heights 18")	\$25	
<input type="checkbox"/> 12" (For Back Heights 19"-22")	\$25	
<input type="checkbox"/> 16" (For Back Heights 23"-25")	\$25	
<input type="checkbox"/> Omit Back	(-\$100)	

ARMRESTS

Description	Price	HCPCS Code
<input type="checkbox"/> Bariatric, Removable Height, Adjustable ¹	No Charge	
<input type="checkbox"/> 8"H - 12"H		<input type="checkbox"/> 10"H-14"H
<input type="checkbox"/> Height Adjustable Cantilever Armrests ²	\$195	
Angle-Adjustable: -30° through +30°		

ARMPADS

Description	Price	HCPCS Code
<input type="checkbox"/> Straight, Full Length (2"x14")	Standard	
<input type="checkbox"/> Left		<input type="checkbox"/> Right
<input type="checkbox"/> Straight, Desk Length (2"x10")	No Charge	
<input type="checkbox"/> Left		<input type="checkbox"/> Right
<input type="checkbox"/> Waterfall, Full Length (2"x14")	No Charge	
<input type="checkbox"/> Left		<input type="checkbox"/> Right
<input type="checkbox"/> Waterfall, Desk Length (2"x10")	No Charge	
<input type="checkbox"/> Left		<input type="checkbox"/> Right
<input type="checkbox"/> Falcon Gel, Full Length, (3.5"x14")	\$150 pr.	
<input type="checkbox"/> Left		<input type="checkbox"/> Right
<input type="checkbox"/> Falcon Gel, Desk Length, (3.5"x10")	\$115 pr.	
<input type="checkbox"/> Left		<input type="checkbox"/> Right
<input type="checkbox"/> Flat Bariatric, Full Length ²	No Charge	
<input type="checkbox"/> Left		<input type="checkbox"/> Right

JOYSTICK MOUNTING BLOCKS

Description	Price	HCPCS Code
<input type="checkbox"/> Quick Disconnect ³	No Charge	
<input type="checkbox"/> Vertical Adjustment Clamp	\$95	K0108
<input type="checkbox"/> Figure 8 style (For use with waterfall armpads)	No Charge	

TRU-COMFORT™ SEATING

Description	Price	HCPCS Code
-------------	-------	------------

Please refer to TRU-Comfort Cushion and TRU-Comfort Back order forms for detailed pricing, sizes and codes.

TRU-Comfort™ Back Cushion

<input type="checkbox"/> 20"W	\$595	E2620
<input type="checkbox"/> 22"W	\$695	E2621

Back Height:⁴

<input type="checkbox"/> 22" H		<input type="checkbox"/> 25" H	No Charge
--------------------------------	--	--------------------------------	-----------

Cover:

<input type="checkbox"/> Standard Allure leather-like cover	No Charge	
<input type="checkbox"/> Plus 4-way stretch material cover	No Charge	

TRU-Comfort™ Seat Cushion General Use
Includes Allure leather-like cover

<input type="checkbox"/> 20" x 16" - 20" x 18"	\$380	E2601
<input type="checkbox"/> 20" x 20" - 20" x 22"	\$380	E2601
<input type="checkbox"/> 22" x 16" - 22" x 24"	\$480	E2602

TRU-Comfort™ Plus Seat Cushion Skin Protection
Includes 4-way stretch material cover

<input type="checkbox"/> 20" x 16" - 20" x 18"	\$380	E2603
<input type="checkbox"/> 20" x 20" - 20" x 22"	\$380	E2603
<input type="checkbox"/> 22" x 16" - 22" x 24"	\$480	E2604

POWER POSITIONING ELECTRONICS

Description	Price	HCPCS Code
Single Actuator Electronics		
<input type="checkbox"/> Through Toggle Box	No Charge	
<input type="checkbox"/> Left Mount		<input type="checkbox"/> Right Mount
<input type="checkbox"/> Through Single Switch Module (Q-Logic or NE Only)	\$500	
<input type="checkbox"/> NE+ Through Joystick or Single Switch	\$1,175	E2310
<input type="checkbox"/> Through Q-Logic EX Controller	\$1,175	E2310

HEADRESTS

Description	Price	HCPCS Code
<input type="checkbox"/> No Headrest Required	No Charge	
TRU-Comfort™ Headrest⁵		
<input type="checkbox"/> 8" Wide Leatherette	\$205	E0955
<input type="checkbox"/> 8" TRU-Comfort Plus	\$205	E0955
<input type="checkbox"/> 10" Wide Leatherette	\$205	E0955
<input type="checkbox"/> 10" TRU-Comfort Plus	\$205	E0955
<input type="checkbox"/> Removable Headrest Bracket ⁶	\$210	E1028
Stealth		
<input type="checkbox"/> Small (9.75"W x 3"H)	\$205	E0955
<input type="checkbox"/> Large (11"W x 6"H)	\$205	E0955
<input type="checkbox"/> Small Comfort Plus (10"W)	\$205	E0955
<input type="checkbox"/> Large Comfort Plus (14"W)	\$205	E0955
<input type="checkbox"/> Removable Headrest Bracket ⁶	\$210	E1028
<input type="checkbox"/> Swing-away (Flip-down) Headrest Bracket	\$210	E1028
Used With Removable Headrest Bracket		

Medical Applications

<input type="checkbox"/> Small (9.75"W x 3"H)	\$230	E0955
<input type="checkbox"/> Large (11"W x 6"H)	\$230	E0955
<input type="checkbox"/> Removable Headrest Bracket ⁶	\$210	E1028

Aftermarket Bracket

<input type="checkbox"/> Removable Bracket for Aftermarket Headrest	\$210	E1028
---	-------	-------

LEGRESTS

Description	Price	HCPCS Code
<input type="checkbox"/> Heavy Duty Drop-In Legrests^{7,8}	Standard	
<input type="checkbox"/> Angle Adjustable Footplates	Standard	K0040
Angle Adjustable Extension Length:		
<input type="checkbox"/> 12"-14.5"		<input type="checkbox"/> 14.5" - 18"
Angle Adjustable Footplate Size:		
<input type="checkbox"/> 6" x 8"		<input type="checkbox"/> 6" x 11" <input type="checkbox"/> 8" x 11"

FRONT RIGGING ACCESSORIES

Description	Price	HCPCS Code
<input type="checkbox"/> Wheel Bumpers	\$25	
<input type="checkbox"/> POSAlinc Rail Mounted Knee Adductor (pair)	\$464	K0108
<input type="checkbox"/> Ankle Huggers (pair)	\$126	K0108
<input type="checkbox"/> Medium		<input type="checkbox"/> Large
<input type="checkbox"/> Shoe Holders (pair)	\$166	K0108
<input type="checkbox"/> Medium		<input type="checkbox"/> Large

SYNERGY® CUSHIONS

Description	Price	HCPCS Code
-------------	-------	------------

No Cushion Required

Please refer to Synergy order forms for additional cushions with 350 lbs weight capacity.

Spectrum® Visco Cushion Skin Protection & Positioning

<input type="checkbox"/> 20" x 16" - 20" x 18"	\$480	E2607
<input type="checkbox"/> 20" x 20" - 20" x 22"	\$530	E2607
<input type="checkbox"/> 22" x 16" - 24" x 24"	\$530	E2608
<input type="checkbox"/> 26" x 18" - 28" x 28"	\$580	E2608

FOOTNOTES

- Bariatric armrests and bariatric armpads must be used together.
- Height adjustment from 11-17" depends on cane height. Call for details when selecting aftermarket arm troughs or Universal Swivel.
- Not available with waterfall armpads.
- TRU-Comfort Back Height is measured from the top of a 3" seat cushion.
- TRU-Comfort™ Headrest is measured at the front of the pad.
- i-Quantum automatically selects Removable Headrest Bracket when pad is chosen.
- Extensions are measured from top of seatpan to footplate.
- Standard with Heel Loops and Angle Adjustable Footplates

LATERALS

Description	Price	
Stealth Thoracic Laterals (pair)		
<i>Bracket:</i>		
<input type="checkbox"/> 125° Swing-Away Bracket	\$450	E1028
<i>(For Use with TRU-Comfort)</i>		
<input type="checkbox"/> Swing-Away, Rail Mount Bracket	\$450	E1028
<i>(For Use with Synergy Back)</i>		
<i>Pad:</i>		
<input type="checkbox"/> Flat Pad, 3" x 5", Leather-Like Cover	\$200	E0956
<input type="checkbox"/> Flat Pad, 4" x 6", Leather-Like Cover	\$200	E0956
<input type="checkbox"/> Curved Pad, 2" x 3", 4-Way Stretch Cover	\$200	E0956
<input type="checkbox"/> Curved Pad, 3" x 5", 4-Way Stretch Cover	\$200	E0956
<input type="checkbox"/> Curved Pad, 4" x 6", 4-Way Stretch Cover	\$200	E0956

Stealth Pelvic/Thigh Laterals

<i>Side:</i>		
<input type="checkbox"/> Left Side	<input type="checkbox"/> Right Side	
<i>Bracket:</i>		
<input type="checkbox"/> Removable Bracket (ea.)	\$250	E1028
<input type="checkbox"/> Flip Down Bracket (ea.)	\$225	E1028
<i>Pad:</i>		
<input type="checkbox"/> Short Pad, 4" x 4" (ea.)	\$90	E0956
<input type="checkbox"/> Medium Pad, 4" x 8" (ea.)	\$90	E0956

MISCELLANEOUS POSITIONING COMPONENTS

Description	Price	HCPCS Code
<input type="checkbox"/> Therafin Flip-down Knee Abductor Bracket	\$190	E1028
<i>Pad:</i>		
<input type="checkbox"/> Medium	<input type="checkbox"/> Large	\$125
		E0957
<input type="checkbox"/> Stealth Shoe Boxes (pair)	\$475	K0108
<i>Size:</i>		
<input type="checkbox"/> Medium	<input type="checkbox"/> Large	
<input type="checkbox"/> Stealth Padded Shoe Holders (pair)	\$166	K0108
<i>Size:</i>		
<input type="checkbox"/> Medium	<input type="checkbox"/> X-Large	
<input type="checkbox"/> Otto Bock Arm Channels (ea.)	\$102	E2209
<i>Side:</i>		
<input type="checkbox"/> Left	<input type="checkbox"/> Right	
<i>Size:</i>		
<input type="checkbox"/> Small	<input type="checkbox"/> Medium	<input type="checkbox"/> Large
<input type="checkbox"/> Otto Bock Flat Hand Pad (ea.)	\$51	
<i>Side:</i>		
<input type="checkbox"/> Left	<input type="checkbox"/> Right	
<i>Size:</i>		
<input type="checkbox"/> Medium	<input type="checkbox"/> Large	

Please see positioning components order form for additional types, sizes and details.

ACCESSORIES

Description	Price	
<input type="checkbox"/> Quantum Backpack ¹	\$60	
<input type="checkbox"/> Oxygen Holder	\$150	E2208
<input type="checkbox"/> Cup Holder	\$17	
<i>Side:</i>		
<input type="checkbox"/> Left	<input type="checkbox"/> Right	

LAP BELTS

Description	Price
<input type="checkbox"/> 50" Lap Belt	Standard
<input type="checkbox"/> 60" Lap Belt	Standard
<input type="checkbox"/> 70" Lap Belt	Standard
<input type="checkbox"/> 80" Lap Belt	Standard
<input type="checkbox"/> 90" Lap Belt	Standard

BATTERY OPTIONS

Description	Price	HCPCS Code
<input type="checkbox"/> Group 24, 70 Amp, Gel (Universal)	\$352 ea.	E2363
<input type="checkbox"/> Group 24, 70 Amp, Gel (MK)	\$352 ea.	E2363
<input type="checkbox"/> Group 34, 60-Amp Gel ²	\$330 ea.	K0108
<input type="checkbox"/> NF-22, 50-Amp Batteries		
<input type="checkbox"/> Maintenance Free AGM	\$255 ea.	E2361
<input type="checkbox"/> Maintenance Free Gel Cell (Universal)	\$295 ea.	E2361
<input type="checkbox"/> Maintenance Free Gel Cell (MK)	\$295 ea.	E2361
<i>Installation:</i>		
<input type="checkbox"/> Batteries Installed	<input type="checkbox"/> Do Not Install	

FOOTNOTES

1. Backpack may interfere w/ other rear accessories.
2. Required with Super Low Option.