

Quantum® 600 XL HD Series

Group 3 Heavy Duty
Single Power & Multiple Power Order Form
400 lbs. weight capacity



Quantum Rehab®

A Division of Pride Mobility Products Corporation®

182 Susquehanna Ave., Exeter, PA 18643

Phone: (866)800-2002 • Fax: (866) 707-3422

Account Number: _____

Provider Name: _____

Contact: _____

Phone: _____

Fax: _____

Date: _____

PO#: _____

Marked For: _____

Ship To: _____

Address: _____

City: _____ State: _____ Zip: _____

Discount: _____

Terms: _____

Freight: _____

Taken By: _____

SET-TO-SPEC®

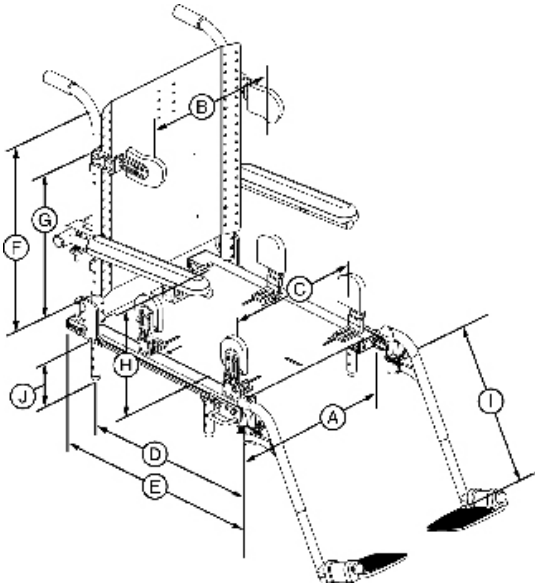

Please supply patient information for optimal setup prior to shipping.

Client Height: _____

Client Weight: _____

A. Seat Width: _____

B. Lateral Offset: _____

C. Hip/Thigh Lateral Offset: _____

D. Center of Gravity: *Optimized based on seat dimensions*

E. Seat Depth: _____

F. Back Height from Pan: _____

G. Lateral Height from Pan: _____

H. Armrest Height from Pan: _____

I. Rigging Length (whole numbers only): _____

J. Seat to Floor Height (circle one): _____

Seat	Seat-To-Floor Heights			
TRU-Balance® Bariatric Tilt	18.725"	19.625"	20.5"	21.375"

Seat to floor height are +/- 1/8" with 24"W x 24"D with Flat-Free tires (add 3/8" for pneumatic tires). Increased widths may increase lowest seat to floor heights.

Clinician Notes: _____

* While every effort will be taken to ensure items will be preset to your specifications prior to shipping, variations in options may effect final settings.

DME providers are responsible for determining appropriate billing codes when submitting for insurance reimbursement.

HCPSC codes should not be considered as legal advice. All prices are MSRP.

BASE MODEL

Description	Price	HCPSC Code
<input type="checkbox"/> Quantum 600 XL (HD) 3SPHD-SS	\$7,221	K0858
<input type="checkbox"/> Quantum 600 XL (HD) 3MPHD-SS	\$7,021	K0862

COLORS

Metallic Colors:

- Champagne
- Candy Apple Red
- Viper Blue
- Onyx Black
- Sunburst Orange
- Pearl Pink
- Pewter
- Silver
- Emerald Green
- Graphite Blue
- Sapphire Blue

Solid Colors:

- Mariner Blue
- Cardinal Red
- Spring Green
- Solar Yellow
- Violet
- Kelly Green
- Tangerine

BASE MOUNTED FOOT PLATFORM

Description	Price
<input type="checkbox"/> No Base Mounted Front Platform	No Charge
<input type="checkbox"/> Base Mounted Foot Platform	Standard

DRIVE WHEELS

Description	Price
<input type="checkbox"/> 14" Flat-Free	Standard
<input type="checkbox"/> 4" Wide Flat Free, Knobby, Extended-Traction Tires ¹ (Available Thru SOF)	\$551

BATTERY CHARGER



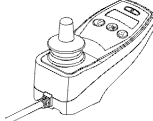
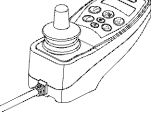

Description	Price
<input type="checkbox"/> 8 Amp, Off-board Charger	Standard

NON EXPANDABLE CONTROLS

Description	Price
<input type="checkbox"/> 75 Amp NE 	Standard
<input type="checkbox"/> 75 Amp NE+ 6-Key For Up To 2 Actuators Thru Joystick 	\$200 <i>Standard on 3SPHD-SS Package</i>

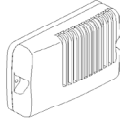
EXPANDABLE CONTROLS

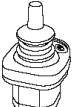
Q-Logic EX Joystick or Enhanced Display must be ordered with a Q-Logic EX Controller and Harness For Expandable Controls

Description	Price	HCPSC Code
<input type="checkbox"/> 100 Amp Q-Logic EX Controller 	\$695	E2377
<input type="checkbox"/> Harness For Expandable Controller	\$350	E2313
<input type="checkbox"/> Q-Logic EX Joystick 	\$700	
<input type="checkbox"/> Q-Logic EX Joystick w/ Light <i>Required For Use With LED Light Package</i> 	\$700	
<input type="checkbox"/> Q-Logic EX Standalone Joystick 	\$700	E2373
<input type="checkbox"/> Q-Logic EX Enhanced Display ² w/ Bluetooth Mouse & IR Capability (KITASMB1678)  Includes: - Q-Logic EX Enhanced Display - Flexible Gooseneck - Enhanced Display Mounting Bracket	\$1,884.93	

PROGRAMMING

Description	Price
<input type="checkbox"/> Q-Logic Handheld Programmer 	\$545
<input type="checkbox"/> Q-Logic PC Programming Cable w/ Disk ³	\$750

JOYSTICK HANDLES

Description	Price	HCPSC Code
<input type="checkbox"/> Standard Knob	Standard	
<input type="checkbox"/> Mushroom Handle	\$71	E2323
<input type="checkbox"/> T-Bar	\$107	E2323
<input type="checkbox"/> Chin Cup	\$71	E2324 ⁴
<input type="checkbox"/> Extended I-Handle	\$71	E2323
<input type="checkbox"/> Soft Ball Handle	\$50	E2323
<input type="checkbox"/> Medium Ball Handle	\$50	E2323
<input type="checkbox"/> Bodypoint 3" Goal Post Handle	\$69	E2323
<input type="checkbox"/> Bodypoint 4" Goal Post Handle	\$69	E2323

JOYSTICK MOUNTING BRACKETS

Description	Price	HCPSC Code
<i>Comes Standard with a Quick Release, Adjustable-Height Joystick Block</i>		
<input type="checkbox"/> Fixed Inline ⁵	Standard	
<input type="checkbox"/> Left		
<input type="checkbox"/> Right		
<input type="checkbox"/> Swing-away	\$210	E1028
<input type="checkbox"/> Left		
<input type="checkbox"/> Right		
<input type="checkbox"/> Inline		
<input type="checkbox"/> Offset		
<input type="checkbox"/> 4" Ext.		
<input type="checkbox"/> 7" Ext.		
<input type="checkbox"/> Multi-axis Fixed	\$100	K0108
<input type="checkbox"/> Left		
<input type="checkbox"/> Right		

FOOTNOTES

1. Increases overall base width by 1.5"
2. All mounting hardware is included in kit. See Specialty Electronics order form for additional mounting options and secondary controls. Bluetooth mouse emulator requires a run plug harness for either static or power seating. Additional fees will apply.
3. Works with NE+ and Q-Logic EX only
4. Use code E2323 when not used in conjunction with a chin control.
5. Not available with Q-logic EX Stand Alone Joystick.

TRU-BALANCE® POWER POSITIONING SYSTEMS

Description	Price	HCPCS Code
<input type="checkbox"/> TRU-Balance® HD Power Tilt <i>40 Degrees CG Tilt with Full Drive Lock-out Set at 20 Degrees</i>	\$7,250	K0108

SEATING SPECIFICATIONS

Seat Width:				
<input type="checkbox"/> 20"	<input type="checkbox"/> 21"	<input type="checkbox"/> 22"	<input type="checkbox"/> 23"	<input type="checkbox"/> 24"
Seat Width Package:				
<input type="checkbox"/> 20"W-24"W				
Seat Depth:				
<input type="checkbox"/> 15"	<input type="checkbox"/> 16"	<input type="checkbox"/> 17"	<input type="checkbox"/> 18"	<input type="checkbox"/> 19"
<input type="checkbox"/> 20"	<input type="checkbox"/> 22"	<input type="checkbox"/> 23"	<input type="checkbox"/> 24"	
Seat Depth Package:				
<input type="checkbox"/> 15"D-20"D		<input type="checkbox"/> 20"D-24"D		
Back Cane Height:				
<input type="checkbox"/> 14"	<input type="checkbox"/> 15"	<input type="checkbox"/> 16"	<input type="checkbox"/> 17"	<input type="checkbox"/> 18"
<input type="checkbox"/> 19"	<input type="checkbox"/> 20"	<input type="checkbox"/> 21"	<input type="checkbox"/> 22"	<input type="checkbox"/> 23"
<input type="checkbox"/> 24"	<input type="checkbox"/> 25"			
Back Rest Height:				
<input type="checkbox"/> 18"	<input type="checkbox"/> 19"	<input type="checkbox"/> 20"	<input type="checkbox"/> 21"	<input type="checkbox"/> 22"
<input type="checkbox"/> 23"	<input type="checkbox"/> 24"	<input type="checkbox"/> 25"		

BACK CANES

Description	Price	HCPCS Code
<input type="checkbox"/> Standard Back Canes With Push Handles	Standard	
<input type="checkbox"/> Standard Back Canes, No Push Handles	\$125	
<input type="checkbox"/> Offset (Meso)	\$195	
	<input type="checkbox"/> 2" (1" Per Side)	<input type="checkbox"/> 4" (2" Per Side)
<input type="checkbox"/> Inset (Endo)	\$195	
	<input type="checkbox"/> 2" (1" Per Side)	<input type="checkbox"/> 4" (2" Per Side)

BACK OPTIONS

Description	Price	HCPCS Code
<input type="checkbox"/> Synergy Back with 1.5" Thick Back Cushion	Standard	
<i>Choose Lateral Extension:</i>		
<input type="checkbox"/> 10" (For Back Heights 18")	\$25	
<input type="checkbox"/> 12" (For Back Heights 19"-22")	\$25	
<input type="checkbox"/> 16" (For Back Heights 23"-25")	\$25	
<input type="checkbox"/> Omit Back	(-\$100)	

ARMRESTS

Description	Price
<input type="checkbox"/> Bariatric, Removable Height, Adjustable ¹	No Charge
	<input type="checkbox"/> 8"H - 12"H <input type="checkbox"/> 10"H-14"H
<input type="checkbox"/> Height Adjustable Cantilever Armrests ²	\$195

ARMPADS

Description	Price
<input type="checkbox"/> Straight, Full Length (2"x14")	Standard
	<input type="checkbox"/> Left <input type="checkbox"/> Right
<input type="checkbox"/> Straight, Desk Length (2"x10")	No Charge
	<input type="checkbox"/> Left <input type="checkbox"/> Right
<input type="checkbox"/> Waterfall, Full Length (2"x14")	No Charge
	<input type="checkbox"/> Left <input type="checkbox"/> Right
<input type="checkbox"/> Waterfall, Desk Length (2"x10")	No Charge
	<input type="checkbox"/> Left <input type="checkbox"/> Right
<input type="checkbox"/> Falcon Gel, Full Length, (3.5"x14")	\$160 pr.
	<input type="checkbox"/> Left <input type="checkbox"/> Right
	<input type="checkbox"/> Full Length Gel Armpad Mounting Plate (Required)
<input type="checkbox"/> Falcon Gel, Desk Length, (3.5"x10")	\$125 pr.
	<input type="checkbox"/> Left <input type="checkbox"/> Right
	<input type="checkbox"/> Desk Length Gel Armpad Mounting Plate (Required).
<input type="checkbox"/> Flat, Bariatric ¹	No Charge
	<input type="checkbox"/> Left <input type="checkbox"/> Right

TRU-COMFORT™ SEATING

Description	Price	HCPCS Code
-------------	-------	------------

Please refer to TRU-Comfort Cushion and TRU-Comfort Back order forms for detailed pricing, sizes and codes.

TRU-Comfort™ Back Cushion

<input type="checkbox"/> 20"W	\$595	E2620
<input type="checkbox"/> 22"W	\$695	E2621

Back Height:³

<input type="checkbox"/> 22" H	<input type="checkbox"/> 25" H	No Charge
--------------------------------	--------------------------------	-----------

Cover:

<input type="checkbox"/> Standard Allure leather-like cover	No Charge
<input type="checkbox"/> Plus 4-way stretch material cover	No Charge

TRU-Comfort™ Seat Cushion General Use

Includes Allure leather-like cover

<input type="checkbox"/> 20" x 16" - 20" x 18"	\$380	E2601
<input type="checkbox"/> 20" x 20" - 20" x 22"	\$380	E2601
<input type="checkbox"/> 22" x 16" - 22" x 24"	\$480	E2602

TRU-Comfort™ Plus Seat Cushion Skin Protection

Includes 4-way stretch material cover

<input type="checkbox"/> 20" x 16" - 20" x 18"	\$380	E2603
<input type="checkbox"/> 20" x 20" - 20" x 22"	\$380	E2603
<input type="checkbox"/> 22" x 16" - 22" x 24"	\$480	E2604

POWER POSITIONING ELECTRONICS

Description	Price	HCPCS Code
-------------	-------	------------

Single Actuator Electronics

<input type="checkbox"/> Through Toggle Box	No Charge	
	<input type="checkbox"/> Left Mount <input type="checkbox"/> Right Mount	
<input type="checkbox"/> Through Single Switch Module (Q-Logic EX Only)	\$500	
<input type="checkbox"/> NE+ Through Joystick or Single Switch	\$1,175	E2310
<input type="checkbox"/> Through Q-Logic EX Controller	\$1,175	E2310

HEADRESTS

Description	Price	HCPCS Code
-------------	-------	------------

No Headrest Required No Charge

TRU-Comfort™ Headrest⁴

<input type="checkbox"/> 8" Wide Leatherette	\$205	E0955
<input type="checkbox"/> 8" TRU-Comfort Plus	\$205	E0955
<input type="checkbox"/> 10" Wide Leatherette	\$205	E0955
<input type="checkbox"/> 10" TRU-Comfort Plus	\$205	E0955
<input type="checkbox"/> Removable Headrest Bracket	\$210	E1028

Stealth

<input type="checkbox"/> Small (9.75"W x 3"H)	\$205	E0955
<input type="checkbox"/> Large (11"W x 6"H)	\$205	E0955
<input type="checkbox"/> Small Comfort Plus (10"W)	\$142	E0955
<input type="checkbox"/> Large Comfort Plus (14"W)	\$142	E0955
<input type="checkbox"/> Removable Headrest Bracket	\$210	E1028
<input type="checkbox"/> Swing-away (Flip-down) Headrest Bracket	\$210	E1028

Used With Removable Headrest Bracket

Aftermarket Bracket

<input type="checkbox"/> The World's Best Removable Headrest Hardware	\$210	E1028
---	-------	-------

LEGRESTS

Description	Price	HCPCS Code
-------------	-------	------------

Heavy Duty Drop-In Legrests^{5,6} **Standard**

Angle Adjustable Footplates Standard

Angle Adjustable Extension Length:

12"-14.5" 14.5" -18"

Angle Adjustable Footplate Size:

6" x 8" 6" x 11" 8" x 11"

FOOTNOTES

- Bariatric armrests and bariatric armpads must be used together.
- Height adjustment from 11-17" depends on cane height. Call for details when selecting aftermarket arm troughs or Universal Swivel.
- TRU-Comfort Back Height is measured from the top of a 3" seat cushion.
- TRU-Comfort™ Headrest is measured at the front of the pad.
- Extensions are measured from top of seatpan to footplate.
- Standard with Heel Loops and Angle Adjustable Footplates

FRONT RIGGING ACCESSORIES

Description	Price	HCPCS Code
<input type="checkbox"/> Wheel Bumpers	\$25	
<input type="checkbox"/> POSAlinc Rail Mounted Knee Adductor (pair)	\$287	K0108
<input type="checkbox"/> Ankle Huggers (pair)	\$126	K0108
<input type="checkbox"/> Medium <input type="checkbox"/> Large		
<input type="checkbox"/> Bariatric Calf Panel		
<input type="checkbox"/> 22"W (Fits 20"W-24"W)	\$135	

New!

SYNERGY® CUSHIONS

Description	Price	HCPCS Code
<input type="checkbox"/> No Cushion Required		
<i>Please refer to Synergy order forms for additional cushions with 350 lbs weight capacity.</i>		
Spectrum® Visco Cushion Skin Protection & Positioning		
<input type="checkbox"/> 20" x 16" - 20" x 18"	\$480	E2607
<input type="checkbox"/> 20" x 20" - 20" x 22"	\$530	E2607
<input type="checkbox"/> 22" x 16" - 24" x 24"	\$530	E2608

LATERALS

Description	Price	HCPCS Code
<input type="checkbox"/> Stealth Thoracic Laterals (pair)		
Bracket:		
<input type="checkbox"/> 125° Swing-Away Bracket	\$450	E1028
<i>(For Use with TRU-Comfort)</i>		
<input type="checkbox"/> Swing-Away, Rail Mount Bracket	\$450	E1028
<i>(For Use with Synergy Back)</i>		
Pad:		
<input type="checkbox"/> Flat Pad, 3" x 5", Leather-Like Cover	\$200	E0956
<input type="checkbox"/> Flat Pad, 4" x 6", Leather-Like Cover	\$200	E0956
<input type="checkbox"/> Curved Pad, 2" x 3", 4-Way Stretch Cover	\$200	E0956
<input type="checkbox"/> Curved Pad, 3" x 5", 4-Way Stretch Cover	\$200	E0956
<input type="checkbox"/> Curved Pad, 4" x 6", 4-Way Stretch Cover	\$200	E0956
<input type="checkbox"/> Stealth Pelvic/Thigh Laterals		
Side:		
<input type="checkbox"/> Left Side <input type="checkbox"/> Right Side		
Bracket:		
<input type="checkbox"/> Removable Bracket (ea.)	\$250	E1028
<input type="checkbox"/> Removable Bracket w/ 1" Offset (ea.)	\$325	E1028
<input type="checkbox"/> Flip Down Bracket (ea.)	\$225	E1028
Pad:		
<input type="checkbox"/> Short Pad, 4" x 4" (ea.)	\$90	E0956
<input type="checkbox"/> Medium Pad, 4" x 8" (ea.)	\$90	E0956
<input type="checkbox"/> Long Pad, 4" x 12" (ea.)	\$90	E0956
Adapter:		
<input type="checkbox"/> 2" Depth/Height Adapter Plate ¹	\$25	K0108

MISCELLANEOUS POSITIONING COMPONENTS

Description	Price	HCPCS Code
<input type="checkbox"/> Therafin Flip-down Knee Abductor Bracket	\$172	E1028
Pad:		
<input type="checkbox"/> Medium <input type="checkbox"/> Large	\$135	E0957
<input type="checkbox"/> Stealth Foot Boxes (pair)	\$475	K0108
<input type="checkbox"/> Medium <input type="checkbox"/> Large		
<input type="checkbox"/> Stealth Padded Shoe Holders (pair)	\$166	K0108
<input type="checkbox"/> Medium <input type="checkbox"/> X-Large		
<input type="checkbox"/> Otto Bock Arm Channels (ea.)	\$104	E2209
Side:		
<input type="checkbox"/> Left <input type="checkbox"/> Right		
Size:		
<input type="checkbox"/> Small <input type="checkbox"/> Medium <input type="checkbox"/> Large		
<input type="checkbox"/> Otto Bock Flat Hand Pad (ea.)	\$52	
Side:		
<input type="checkbox"/> Left <input type="checkbox"/> Right		
Size:		
<input type="checkbox"/> Medium <input type="checkbox"/> Large		

Please see positioning components order form for additional types, sizes and details.

ACCESSORIES

Description	Price	HCPCS Code
<input type="checkbox"/> Quantum Backpack ²	\$60	
<input type="checkbox"/> Oxygen Holder	\$150	E2208
<input type="checkbox"/> Cup Holder	\$17	
Side:		
<input type="checkbox"/> Left <input type="checkbox"/> Right		

LAP BELTS

Description	Price
<input type="checkbox"/> 50" Lap Belt	Standard
<input type="checkbox"/> 60" Lap Belt	Standard
<input type="checkbox"/> 70" Lap Belt	Standard
<input type="checkbox"/> 80" Lap Belt	Standard
<input type="checkbox"/> 90" Lap Belt	Standard

BATTERY OPTIONS

Description	Price	HCPCS Code
<input type="checkbox"/> NF-22, 50-Amp Batteries		
<input type="checkbox"/> Maintenance Free AGM	\$255 ea.	E2361
<input type="checkbox"/> Maintenance Free Gel Cell (Universal)	\$295 ea.	E2361
<input type="checkbox"/> Maintenance Free Gel Cell (MK)	\$295 ea.	E2361
Installation:		
<input type="checkbox"/> Batteries Installed <input type="checkbox"/> Do Not Install		

NOTES:

FOOTNOTES

- Height adapter plate is needed w/ Tru Comfort seat cushion. Not available on the flip down bracket.
- Backpack may interfere w/ other rear accessories.